



Leading Conversion Technology for Power Resilience

BRAVO 25 - 230-277 VAC

User Manual

BEYOND THE INVERTER

THE NEW GENERATION OF POWER CONVERTERS

- **DUAL INPUT INVERTER**
Commercial Power as default source
- **AC BACKUP IN A DC ENVIRONMENT**
Leverage your existing DC infrastructure
- **ONE STOP SHOP**
Wide output power range
- **HARSHEST AC INPUT CONDITIONS**
Without compromising the quality of the AC output

INVERTERS

Bravo 25 - 48/230-277

Bravo 25 - 110/230-277

Bravo 25 - 380/230-277



Copyright © 2023. Construction électroniques & telecommunications S.A.
All rights reserved. The contents in document are subject to change without notice.
The products presented are protected by several international patents and trademarks.
Address: CE+T S.a, Rue du Charbonnage 12, B 4020 Wandre, Belgium
www.cet-power.com - info@cet-power.com

VERSION 1.3

Contact us:  www.cet-power.com

| Follow us on social media:



Table of Contents

1. Introduction to CE+T	6
2. Abbreviations	7
3. Warranty and Safety Conditions	8
3.1 Disclaimer	8
3.2 Technical care	8
3.3 Installation	9
3.3.1 Handling.....	9
3.3.2 Surge and Transients.....	10
3.3.3 Other.....	10
3.4 Maintenance	10
3.5 Replacement and Dismantling.....	10
4. ECI Technology.....	11
4.1 On-line Mode	12
4.2 Safe Mode.....	12
4.3 EPC Mode	12
4.4 Mix Mode & Walk-in Mode.....	12
5. Building Blocks	13
5.1 Inverter	13
5.2 Specifications.....	13
5.3 Controller - Inview S.....	15
5.3.1 Inview S - Connections.....	15
5.4 Inview X	16
5.4.1 Inview X - Connections.....	16
6. Accessories	18
6.1 Cabinet	18
6.2 Manual By-Pass	18
6.3 AC Distribution Unit	18
6.3.1 Miniature Circuit Breakers	18
6.3.2 MCCB.....	19
7. System Design.....	20
7.1 A la Carte	20
8. Installation of Bravo 25 Shelf	21
8.1 Mounting kit for Bravo 25 shelf.....	21
8.2 Electrical installation for Bravo 25 shelf	22
8.2.1 Pre requisites	22
8.2.2 Bravo 25 - 230-277 Single-phase shelf - Terminations.....	23
8.2.3 Bravo 25 - 230-277 Three-phase shelf - Terminations	24
8.2.4 Grounding	25
8.2.5 DC Connection	25

8.2.6	AC Input Connection	25
8.2.7	AC Output Connection	26
8.2.8	Signalling	26
8.2.9	Remote ON/OFF.....	27
8.2.10	Internal BUS A and B	27
8.2.11	Shelf rear cover.....	27
9.	Installation of Cabinet (A la Carte)	28
9.1	Unpacking the system	28
9.2	Module Packing.....	28
9.3	Removing the cabinet rear protection	29
9.4	Hardware Connections	29
9.5	Electrical Installation	30
9.5.1	Positioning	30
9.5.2	Cabling.....	31
9.5.3	Grounding	31
9.5.4	Surge Suppression	31
9.5.5	AC Input (X2) and Output (X4)	32
9.5.6	DC (X1)	33
9.5.7	Connection table – DC 48 Vdc (X1)	33
9.5.8	Connection table – DC 110 Vdc (X1)	33
9.5.9	Connection table – DC 380 Vdc (X1)	34
9.5.10	Connection table – AC Input (X2) & Output (X4).....	34
9.5.11	Signalling	35
10.	Operation.....	37
10.1	Inverter module.....	37
10.2	Inview S - LCD Interface.....	38
10.2.1	LED Indications	38
10.2.2	Menu Structure	39
10.3	Inview X - LCD Interface.....	40
10.3.1	Menu Structure	41
10.3.2	LED Indications	42
10.4	LCD interface - Terminology	42
10.5	Inview S and X - Web Interface.....	43
10.5.1	Login.....	44
10.5.2	Interface Areas	44
10.5.3	Widgets.....	46
10.6	Web page Controls	47
11.	Inserting/removing/replacing - modules.....	49
11.1	Bravo 25 Inverter.....	49
11.1.1	Removal.....	49
11.1.2	Inserting.....	49
11.2	Inview S - Panel Mounting.....	50
11.3	Inview X - Panel Mounting.....	51
11.4	Fan replacement	52

12. AC Output Distribution.....	53
12.1 Miniature Circuit breaker Installation/Removal.....	53
12.2 MCCB.....	53
13. Manual By-Pass (MBP).....	54
13.1 Pre-requisites.....	54
13.2 MBP Auxiliary Connection.....	54
13.3 Manual Bypass operation	55
13.3.1 MBP - Single rotary switch.....	55
13.3.2 MBP - Three individual switches.....	56
14. Finishing	57
15. Commissioning	58
15.1 Check list.....	59
16. Trouble Shooting and Defective Situations Fixing.....	60
16.1 Trouble Shooting	60
16.2 Defective modules.....	61
17. Maintenance.....	62
17.1 Access Inview with Laptop	62
17.2 Manual check.....	62
17.3 Optional	62
17.4 Manual By-Pass	62
18. Service	63
19. Appendix.....	64
19.1 Mains connection, Single phase	64
19.2 Mains connection, Three phases.....	65
19.3 Bravo 25 - Dimensions.....	66
19.3.1 Module.....	66
19.3.2 Shelf	66

Release Note:

Version	Release date (DD/MM/YYYY)	Modified page number	Modifications
1.0	03/08/2022	-	First release of the Manual
1.1	05/07/2023	-	Added 110 and 380 Vdc details
1.2	22/12/2023	25 & 32	Added RCD Recommendation
		-	Update to Inview SW 6.0
1.3	09/04/2024	24	Updated part number in section "8.2.3 Bravo 25 - 230-277 Three-phase shelf - Terminations", page 24

1. Introduction to CE+T

CE+T Power designs, manufactures, and markets a range of products for industrial operators, with mission critical applications, who are not satisfied with existing AC backup system performances and related maintenance costs.

Our product is an innovative AC backup solution that unlike most used UPS's

- Maximizes the operator's applications uptime;
- Operates with lowest OPEX;
- Provides best protection to disturbances;
- Optimizes footprint.

Our systems are:

- Modular
- Truly redundant
- Highly efficient
- Maintenance free
- Battery friendly

CE+T power puts 60+ years expertise in power conversion together with worldwide presence to provide customized solutions and extended service 24/7 - 365 days per year.

2. Abbreviations

AC	Alternating current
CB	Circuit Breaker
DC	Direct current
DHCP	Dynamic Host Configuration Protocol
DSP	Digital Signal Processor
ECI	Enhanced Conversion Innovation
EMBS	External Maintenance Bypass Switch
EPC	Enhanced Power Conversion
ESD	Electro Static Discharge
ETH	Ethernet
G	Ground / Grounding
HTTP	HyperText Transfer Protocol
HTTPS	Secure HyperText Transfer Protocol
LAN	Local Access Network
MBB	Measure Box Battery
MBP	Manual By-pass
MCB	Miniature Circuit Breaker
MCCB	Molded Case Circuit Breaker
MET	Main Earth Terminal
MIB	Management Information Base
N	Neutral
NTP	Network Time Protocol
NUA	Non-Urgent Alarm
PCB	Printed Circuit Board
PE	Protective Earth (also called Main Protective Conductor)
PEK	Power Extension Kit
PPE	Personal Protective Equipment
PWR	Power
REG	Regular
SNMP	Simple Network Management Protocol
TCP/IP	Transmission Control Protocol/Internet Protocol
TRS	True Redundant Structure
UA	Urgent Alarm
USB	Universal Serial Bus

3. Warranty and Safety Conditions*

WARNING:

The electronics in the power supply system are designed for an indoor, clean environment.

When installed in a dusty and/or corrosive environment, indoor, it is important to:

- Install an appropriate filter on the enclosure door, or on the room's air conditioning system.
- Keep the enclosure door closed during operation.
- Replace the filters on a regular basis.

Important Safety Instructions, Save These Instructions.

3.1 Disclaimer

- The manufacturer declines all responsibilities if equipment is not installed, used or operated according to the instructions herein by skilled technicians according to local regulations.
- Warranty does not apply if the product is not installed, used or handled according to the instructions in the manual.

3.2 Technical care

- This electric equipment can only be repaired or maintained by a “qualified employee” with adequate training. Even personnel who are in charge of simple repairs or maintenance are required to have knowledge or experience related to electrical maintenance.
- Please follow the procedures contained in this Manual, and note all the “DANGER”, “WARNING” AND “NOTICE” marks contained in this Manual. Warning labels must not be removed.
- Qualified employees are trained to recognize and avoid any dangers that might be present when working on or near exposed electrical parts.
- Qualified employees know how to lock out and tag out machines so the machines will not accidentally be turned on and injure employees working on them.
- Qualified employees also know safety related work practices, including those by OSHA and NFPA, as well as knowing what personal protective equipment should be worn.
- All operators are to be trained to perform the emergency shut-down procedure.
- Never wear metallic objects such as rings, watches, or bracelets during installation, service and maintenance of the product.
- Maximum operating ambient temperature is 40°C (104°F).
- Insulated tools must be used at all times when working with live systems.
- When handling the system/units pay attention to sharp edges.
- This product is suitable for use in a computer room.

* These instructions are valid for most CE+T Products/Systems. Some points might however not be valid for the product described in this manual.

3.3 Installation

- This product is intended to be installed only in restricted access areas as defined by local regulations and in accordance with the National Electric Code, ANSI/NFPA 70, or equivalent agencies.
- The Inverter System may contain output over current protection in the form of circuit breakers. In addition to these circuit breakers, the user must observe the recommended upstream and downstream circuit breaker requirements as defined in this manual.
- Please use extreme caution when accessing circuits that may be at hazardous voltages or energy levels.
- The modular Inverter rack is a dual input power supply. The complete system shall be wired in a way that both input and output leads can be de-energized when necessary.
- REG systems and EPC systems that have no AC input wired and connected can be seen as independent power sources. To comply with local and international safety standards N (input) and PE shall be bonded. The bonded connection between N (input) and PE must be removed once the AC input is connected.
- AC and DC circuits shall be terminated with no voltage / power applied (de-energized).
- The safety standard IEC/EN62040-1-1 requires that, in the event of an output short circuit, the Inverter must disconnect in 5 seconds maximum. The parameter can be adjusted on Inview; however, if the parameter is set at a value > 5 seconds, an external protection must be provided so that the short circuit protection operates within 5 seconds. Default setting is 60 seconds.
- The system is designed for installation within an IP20 environment. When installed in a dusty or humid environment, appropriate measures (air filtering) must be taken.
- Environment Conditions:
 - Storage Conditions: -40 to 70°C
 - Relative Humidity: 95%, non-condensing
 - Altitude above sea without de-rating: Less than 1500 m
Greater than 1500 m – de-rating at 0.8% per 100 m
- All illustrations in the manual are for general reference, refer to the technical drawing which is received along with the system for exact information.

3.3.1 Handling

- The cabinet shall not be lifted using lifting eyes.
- Remove weight from the cabinet by unplugging the Inverters. Mark Inverters clearly with shelf and position for correct rebuild. This is especially important in dual or three phase configurations.
- Empty Inverter positions must not be left open. Replace with module or dummy cover.
- Before working on the system, Isolate Uninterrupted Power Supply (UPS) and check for hazardous voltage between all terminals including the protective earth.

3.3.2 Surge and Transients

The mains (AC) supply of the modular Inverter system shall be fitted with Lightning surge suppression and Transient voltage surge suppression suitable for the application at hand. Manufacturer's recommendations of installation shall be adhered to. Selecting a device with an alarm relay for function failure is advised.

Indoor sites are considered to have a working lightning surge suppression device in service.

- Indoor sites Min Class II.
- Outdoor sites Min Class I + Class II or combined Class I+II. The modular Inverter system/rack can reach hazardous leakage currents. Grounding must be carried out prior to energizing the system. Grounding shall be made according to local regulations.

Note:

Choosing and installing surge arrestors must obey to precise technical rules. Distance to equipment to protect, cable gage and cable routing have significant influence on proper device service.

Some areas are more susceptible to be hit by electrical strikes, especially when altitude increases.

Good earthing is also crucial for surge arrestors to work properly.

CE+T declines any liability in regard to damaged caused to equipment not correctly or not sufficiently protected.

3.3.3 Other

- Insulation test (Hi-Pot) must not be performed without instructions from the manufacturer.

3.4 Maintenance

- The Inverter system/rack can reach hazardous leakage currents. Earthing must be carried out prior to energizing the system. Earthing shall be made according to local regulations.
- Prior to any work conducted to a system/unit, make sure that AC input voltage and DC input voltage are disconnected.
- Prior to accessing the system or modules, make sure all source of supply is disconnected.
CAUTION – Risk of electric shock. Capacitors store hazardous energy. Do not remove cover until 5 minutes after disconnecting all sources of supply.
- Some components and terminals carry high voltage during operation. Contact may result in fatal injury.

3.5 Replacement and Dismantling

- ESD Strap must be worn when handling PCB's and open units.
- The Inverter system/rack is not supplied with internal disconnect devices on input nor output.
- CE+T cannot be held responsible for disposal of the Inverter system and therefore the customer must segregate and dispose of the materials which are potentially harmful to the environment, in accordance with the local regulations in force in the country of installation.
- If the equipment is dismantled, to dispose of its component products, you must comply with the local regulations in force in the country of destination and in any case avoid causing any kind of pollution.

Note: To download the latest documentation and software, please visit our website at www.cet-power.com

4. ECI Technology¹

Bravo 25 module built with ECI technology and it is a triple port converter (AC in, DC in, AC out). Sinusoidal output is converted from Mains or/and DC. The block diagram below gives an explicit description of the topology and operation.

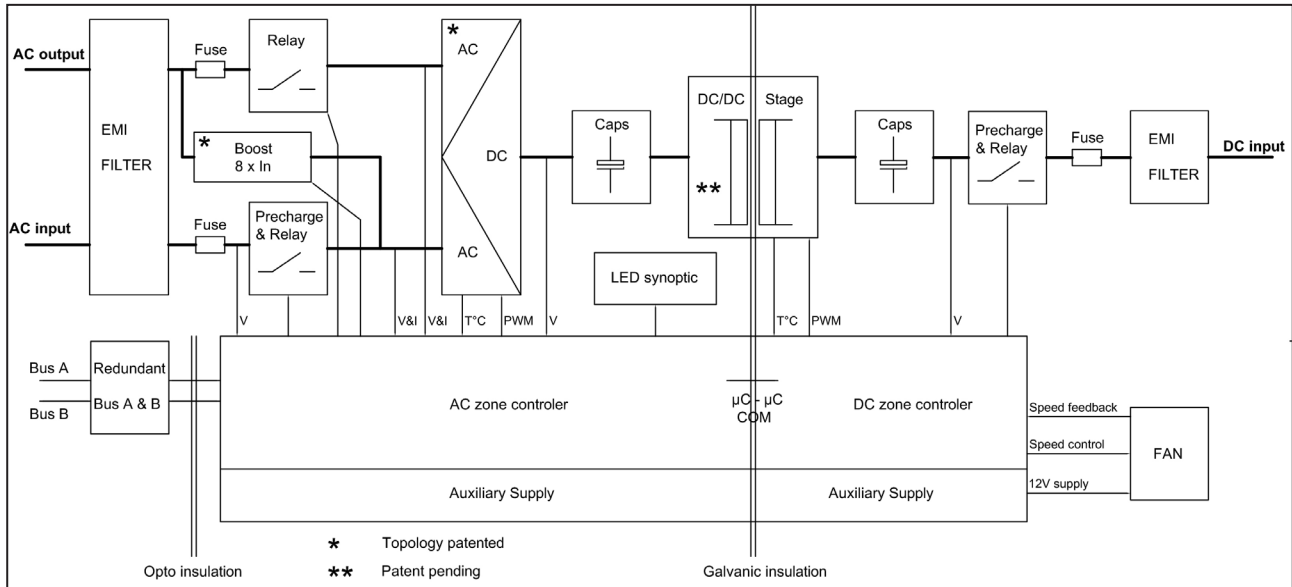

The module is built around the following sub-converters

- AC to DC at input
- DC to DC at input
- DC to AC at output

The energy can flow either from the AC source or the DC source under the control of the local DSP controller. Thanks to internal energy buffering, the output sine wave is constant and disturbance free regardless of the active source.

The BOOST functionality multiplies the nominal current for a period of 20 ms (max) in the event of down stream failures. The upstream breakers do not have to be oversized to prevent tripping. The overload capacity is 125% for 15 seconds.

The ECI works according to True Redundant Structure (TRS) that features decentralized and independent logic, redundant communication bus and three internal levels of disconnection to isolate a module after internal failure.

This functionality is included in every inverter module. Running them in parallel provides a modular system with, no single point of failure, always-conditioned output, high system efficiency and 0 ms source transfer time.

¹ Information and data given in this chapter is intended to serve as an overview of the ECI Technology. Detailed features and parameters for each individual module type in the range may differ and should be referred to in the dedicated data sheet.

4.1 On-line Mode

DC is the primary source of supply whilst Mains (AC) works as the secondary source. Switching time between DC input and AC input is 0 ms (source transfer). The power delivered by the DC source (usually a battery, but possibly any other type of DC generator) is converted to provide regulated and transient-free power to the load. In the event of a short circuit on the load side, the boost is automatic, timely and energized for a specific duration to trip downstream protective devices.

4.2 Safe Mode

Safe mode uses DC as the primary source of supply while Mains (AC) is on standby.

Mains (AC) is normally disconnected through an internal inlet relay and is only connected when down stream clearance is required (boost) or if DC is unavailable.

The transfer between DC and AC results in a typical transfer time of 10 ms.

Typically the safe mode is used in extremely harsh environments such as railways. Under such conditions, it provides extra isolation against mains-borne disturbances.

4.3 EPC Mode

Mains input (AC) is the primary source whilst DC works as backup.

The ECI is designed to operate on Mains on a permanent basis and to deliver output voltage conditioned with low THD.

The output sine wave is physically independent of whether the source is AC (or) DC. If the Mains is out of tolerance or goes down, the Inverter seamlessly switches to DC and the Inverter operates in "Back-up mode" (Changeover switching time is 0 ms).

As soon as the Mains returns to its valid range, the EPC mode is automatically resumed.

The EPC mode offers higher efficiency (up to 96% depending on the model) without compromising the purity of the output sine wave.

Remarks: REG modules:

Inverter modules carrying the ECI logo together with the REG mark work only with DC input. Sinusoidal output is converted from DC with the module operating as a traditional inverter. EPC mode and the boost are not available with REG modules.

4.4 Mix Mode & Walk-in Mode

Under some circumstances the DC and AC sources can be combined. The sequence is defined by a user selectable set of parameters. Start, control and exit are fully automatic.

A specific example of Mix-mode is the Walk-in mode where the transfer from DC source to AC source is ramped up within a fixed and adjustable period of time.

5. Building Blocks

5.1 Inverter

Telecom / Datacom:	Input	48, 110 and 380 Vdc 230, 240 and 277 Vac, 50/60 Hz
	Output	230, 240 and 277 Vac
	Power	3000 VA / 2400 W @ 48 Vdc 3000 VA / 2500 W @ 110 & 380Vdc

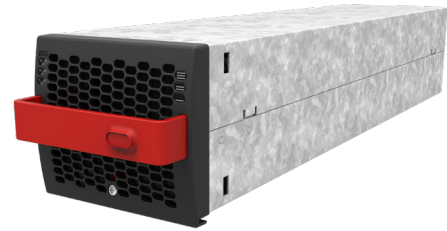

- The Bravo 25 is a triple port inverter.
- Hot swappable and hot pluggable.
- The front LED's indicate the Inverter status and output power.
- The modules is equipped with soft start.
- Module fan is field replaceable.
- 435 mm (D) x 102 mm (W) x 88 mm (H).
- 5 Kg.

5.2 Specifications

Model	Bravo 25 - 48/230-277	Bravo 25 - 110/230-277	Bravo 25 - 380/230-277
Part Number: Module/ Shelf/Shelf without Isolation	T621D30201 / T624730000	T621D50201 / T624D50010 / T624D50000	T621D70201 / T624D70010 / T624D70000
Cooling / Audible noise	Fan forced cooling / <65db @1meter		
MTBF	240 000 hrs (MIL-217-F) at 30°C ambient and 80% load		
Dielectric strength DC/AC	4300 Vdc	2100 Vdc	
RoHS / Material (casing)	Compliant / Aluzinc steel		
Operating T° / Relative Humidity (RH) non-condensing	Tested according ETS300-019-2-3 Class 3.1 -20°C to 65°C, power de-rating from 40°C to 65°C / Max RH 95% for 96 hours per year		
Storage T° / Relative Humidity (RH) non-condensing	Tested according ETS300-019-2-1 Class 1.2 -40°C to 70°C / Max RH 95% for 96 hours per year		
Public transport T°/Relative Humidity (RH) non-condensing	Tested according ETS300-019-2-2 Class 3.1 -40°C to 70°C / Max RH 95% for 96 hours per year		
Vibration	GR63 office vibration 0 to 100 hz-0.1 g / transport vibration 5-100 Hz 0.5 g 100 to 500 hz-1.5 g / Drop test		
Altitude above sea without de- rating of power	< 1500 m / derating > 1500 m – 0.8 % per 100 m / max 4000 m		
AC Input Data			
Nominal voltage (current)	230 Vac (11.8 A), 240 Vac (11.0 A) and 277 Vac (9.5 A)		
Voltage range	150 - 293 Vac (derating from 195 to 150 Vac)		

Model	Bravo 25 - 48/230-277	Bravo 25 - 110/230-277	Bravo 25 - 380/230-277
Brownout	1600 W @150 Vac / 2400 W (48 Vdc), 2500 W (110 & 380 Vdc) @195 Vac linear decreasing		
Power factor / THD	> 0.99 / < 3%		
Frequency (Synchronization range)	50 Hz (47 - 53 Hz) or 60 Hz (57 - 63 Hz)		
DC Input Data			
Nominal voltage (range)	48 Vdc (32 - 63 Vdc)	110 Vdc (90 - 150 Vdc)	336 Vdc (200 - 430 Vdc)
Nominal current	53.4 A	24.3 A	8 A
Maximum input current (for 15 seconds) / voltage ripple	66.8 A / < 10 mV RMS	30.3 A / < 10 mV RMS	9.9 A / < 250 mV RMS
Reverse polarity protection	Yes		
AC Output Data			
Efficiency AC to AC (EPC) / DC to AC	> 96% / > 93.7%	> 96% / > 93.7%	> 96% / > 94.5%
Nominal voltage (User selectable)	230 Vac / 13.1 A, 240 Vac / 12.5 A and 277 Vac / 10.8 A (200 - 277 Vac)		
Frequency / frequency accuracy	50 or 60 Hz / 0.03%		
Nominal Output power	3 kVA / 2.4 kW	3 kVA / 2.5 kW	3 kVA / 2.5 kW
Short time overload capacity	125% (15 seconds)		
Admissible load power factor	Full power rating from 0 inductive to 0 capacitive		
Total harmonic distortion (resistive load)	< 3%		
Load impact recovery time (10% - 90%)	≤ 0.4 ms		
Nominal current	13 A @ 230 Vac		
Crest factor at nominal power	3 : 1 for load P.F. ≤ 0.7		
Short circuit clear up capacity at AC input / On battery	109 A / 31 Arms for 20 ms	109 A / 34 Arms for 20 ms	
Short circuit current after > 20 ms	22.5 A for 15 seconds		
AC Output voltage stability	±1% from 10% to 100% load		
Static / Dynamic voltage regulation	±1% between 10% and 100% load / <5% from 0 to 100% to 0 load impact (100 ms)		
In Transfer Performance			
Max. Voltage interruption / total transient voltage duration (max)	0 sec / 0 sec		

Model	Bravo 25 - 48/230-277	Bravo 25 - 110/230-277	Bravo 25 - 380/230-277
Signalling & Supervision			
Display	Synoptic LEDs on module and touch screen with Inview S and Inview X		
Supervision / Part number	Inview ranges: Inview X - T602004200, Inview S - T602004100 and Inview GW - T602004000		
Remote ON/OFF	At rear terminal of the shelf		
Battery Monitoring / Part number	MBB (Measure Box Battery) - 6 dry contacts and 8 digital Inputs / T602006000		
Safety & EMC			
Electrical Safety	EN60950-EN62040-1-UL1778-IEC62109/1-IEC62109/2		
EMC	EN300386V1.6.1 / EN61000-1-2-3-4		
Environment	GR3108 class 2 for outdoor		

5.3 Controller - Inview S

Inview S is an advanced monitoring and controller unit for **Bravo 25**, **Bravo 10**, **Sierra 25**, and **Sierra 10** power systems. It allows the user to easily access the system information through inbuilt powerful touch screen graphic display. In addition to the touch screen display, the user can also access the system information through the web interface and SNMP protocol.

The Inview S interface provides the user to access the configuration and setup files of the modules in the system. Also, it is a controller for DC regulation.

Inview S can monitor up to 32 inverters/converters and featured with:

- LCD touch screen display
- 2 Digital Inputs
- 2 Output Relay contacts
- Records 5000 events as FIFO



5.3.1 Inview S - Connections

Inview S is composed of multiple network ports and inbuilt free potential contacts.

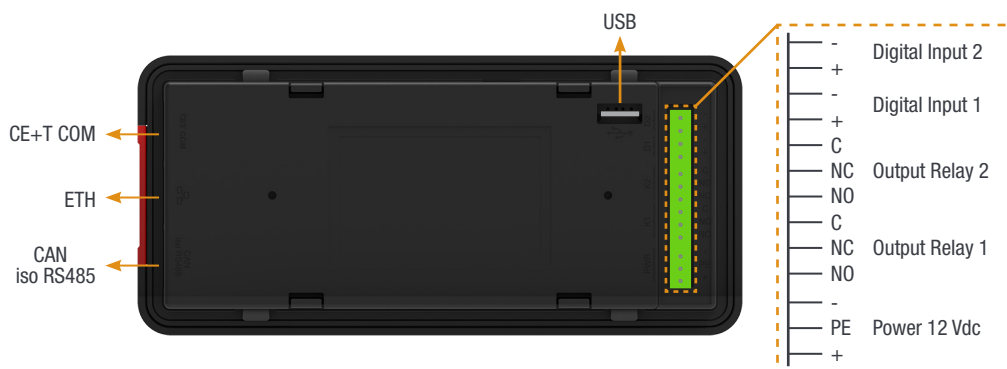

- **CE+T COM** port is dedicated to establish connection between Inview S and Bravo shelf.
- **ETH** () port is used for network connectivity and user can access the system information in the Web Interface.

- **CAN / iso RS485** port is used to establish communication between Inview S and MBB.
- **USB** port is used to access the Inview S configuration and setup files.
- **Digital Inputs (D1 and D2):** Two potential free Digital Inputs are available for customer connections.
 - Digital Input 1 is assigned for MBP operation if used.
 - Digital Input 2 is assigned for Surge Arrester if used.
- **Output Relays (K1 and K2):** Two output relays are available and can be used for Major and Minor Alarms.
- **Power:** The unregulated separate +12 V power supply is required for powering Inview S and this power should not be shared with other devices. (CET can provide Auxiliary Power Supply converter and the part number is T602004120).

5.4 Inview X

Inview X is an advanced monitoring and controller unit for Bravo 10, Bravo 25, Sierra 10 and Sierra 25 power systems. It allows the user to easily view, access, configure the system information through LCD screen graphic display and web interface. The home screen of both LCD and web interface provides a summary of system power, modules, batteries, and events information.



The Ethernet ports in Inview X allow multiple communication points for remote communication, Web interface, and connecting the accessories such as Measure Box Battery, PEK, and Gateway.

Inview X interface provides the user access to the configuration and setup files of the modules that are connected in the system. It is also a controller for DC regulation.

Inview X is featured with:

- Monitor up to 32 inverters
- 7" LCD touch screen display
- Two Digital Inputs and two Output Relay contacts
- Records 5000 events as FIFO

5.4.1 Inview X - Connections

Inview X composed of multiple network ports and inbuilt free potential contacts.

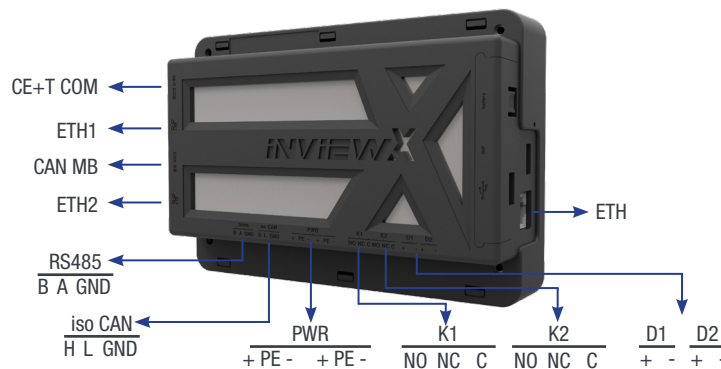

- **CE+T COM** port is dedicated to establish connection between Inview X and Sierra - shelf.

- ETH ports are used for network connectivity, and user can access the system information through the web interface.
 - **ETH Front:** DHCP server, providing access to the configuration at URL <https://inview.local> or <https://10.250.252.1>
 - Intended for direct connection of a laptop computer.
Warning: Do not connect this port to the network, as it might interfere with other DHCP servers.
 - **ETH1:** Main network interface
 - Default static IP address: 10.250.250.1/24
 - It can be configured to other static addresses or as a DHCP client in a web-based configuration interface
 - **ETH2:** Secondary network interface
 - Static IP address: 10.250.251.100/24
 - It is dedicated to CE+T accessories like Inview Gateway and do not connect to the network
- **CAN MB** port is used to share the system information to the Measure Box Battery. It also provides the +12 Vdc power to three accessories which are connected in series.
- **iso CAN** is used for CAN communication.
- **RS485** is used for Modbus communication.
- **USB** port is used for internal factory purpose.
- **Digital Inputs (D1 and D2):** Two potential free Digital Inputs are available for customer connections.
 - Digital Input 1 is assigned for MBP operation if used.
 - Digital Input 2 is assigned for Surge Arrester if used.
- **Output Relays (K1 and K2):** Two output relays are available and can be used for Major and Minor alarms.
- **Power:** The unregulated separate +48 V power supply is required for powering Inview X and this power should not be shared with other devices.

6. Accessories

6.1 Cabinet

Powder coated (RAL 7035), 19 inch Eldon cabinet with 600 x 600 mm foot print. Cabinet designed for top cabling or bottom cabling.

- 1800 mm (600 x 600 mm)
- 2000 mm (600 x 600 mm)

The cabinet comes with a separable top cover to facilitate cabling. Tie strap support at cable entrance/exit. The door accessory is optional.

6.2 Manual By-Pass

The manual by pass operates via manually operated switches to create a short circuit from the AC main input directly to the output AC distribution. Standard manual by-pass is “Make before Break”. When engaged or disengaged, no disturbance is transmitted to the load.

When MBP is engaged, inverter modules are switched off and can be removed without impacting the load. The battery supply is not physically disconnected. After disconnecting the battery supply (by opening the battery breakers), the shelf section is safe for maintenance.

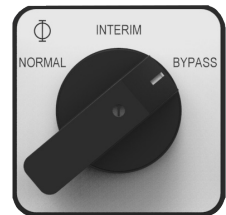

Warning: When the system is in by-pass, the load is subjected to AC main disturbances. Before engaging manual bypass, make sure the voltage difference between AC IN and AC OUT should be less than 5 Vac to limit the inrush current.

6.3 AC Distribution Unit

6.3.1 Miniature Circuit Breakers

The standard AC output distribution unit is designed with a 35 mm DIN rail, Multi Clip termination board and N/PE copper terminal bars, and built as a part of the cabinet.

The Multi Clip offers unique flexibility during installation and expansion. The terminals are spring loaded and adapt contact pressure to the size of conductor. Only one cable can be inserted per spring loaded terminal.

The AC distribution unit is available with 1 pole, 2 pole or 3 poles.

Max current per AC DU is 200 A, max current per terminal connector is 40 A. Two adjacent terminal connectors shall be used for 63 A breakers.



If an alarm is required for AC output breakers, a help contact attached to each individual breaker is used (OF or SD). The alarm function is common and uses one of the digital inputs on the control unit. The help contact limits the breakers quantity.

	Single pole		Double pole		Three pole	
	w/o help contact	With help contact OF/SD	w/o help contact	With help contact OF/SD	w/o help contact	With help contact OF/SD
Up to 40A	24	16	12	9	8	6

6.3.2 MCCB



AC output distribution via MCCB in the range up to 400 A (1p, 2p or 3p).

Max two MCCB per inverter cabinet.

7. System Design

7.1 A la Carte

The A la Carte is pre-assembled and configured as a single phase or three phase system. The system comprises cabinet, inverter sub rack, inverter modules (48, 110 and 380 Vdc), manual by-pass, monitor device and AC output distribution.

The A la Carte is available in EPC (Enhanced Power Conversion) or REG (Regular) mode.

The A la Carte (single phase) accommodates 1 to 32 modules, for max 96 kVA. The A la Carte (three phase) accommodates 3 to 30 modules, for max 90 kVA. By using PEK, the system can parallel up to 810 kVA.

Bravo system featured with:

- Dual input (AC and DC) inverter modules (EPC).
- 96% efficiency during normal operation (EPC).
- Always conditioned and filtered output voltage.
- Seamless transfer (0 ms) between primary and secondary source of supply.
- No single point of failure.
- Flexible AC output distribution.
- Full modularity and redundancy.

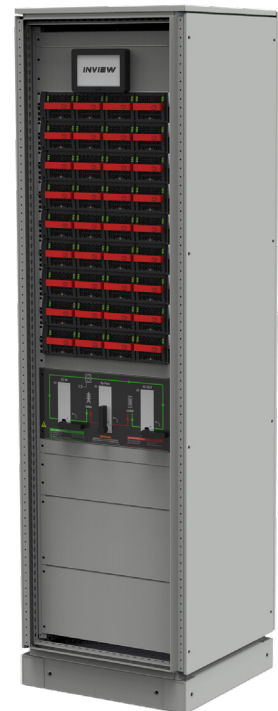

8. Installation of Bravo 25 Shelf

- Read safety instructions prior starting any work.
- Do not attempt to use lifting eyes to erect the cabinet.
- System is preferable handled without modules.
- Pay attention to the module position, make sure that modules are repositioned in the same slot.
- In three phase systems, the modules are configured as per phase 1 (A, R), phase 2 (B, S) and phase 3 (C, T). As long as the system is not in operation, make sure that modules from one phase are not mixed with modules from another phase.
(When the system is running, modules can be moved from one phase to another without issue.)

8.1 Mounting kit for Bravo 25 shelf

The fixing brackets, together with the sliders, allow for different cabinet depths.

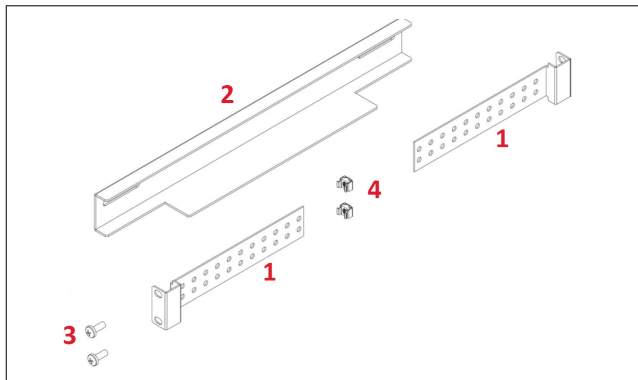

- 1** → Fixing brackets - 4 Nos
- 2** → Slider - 2 Nos
- 3** → Mounting screws - 12 Nos
- 4** → Cage nuts - 12 Nos

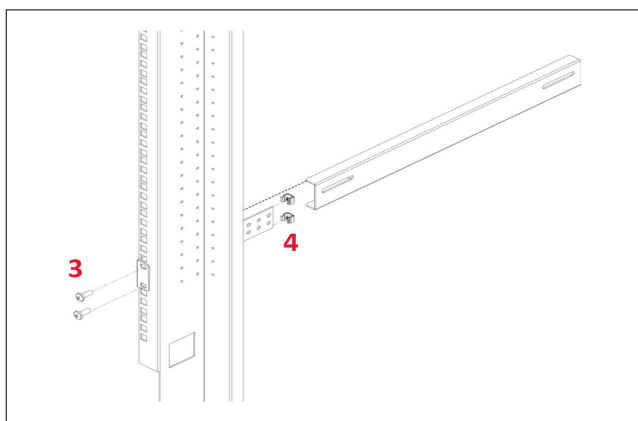

Assemble the sliders and adjust the length to suit the mounting depth.

Fix cage nuts (4) in the cabinet front and rear frame of the left and the right side.

Fix the left and right slider of the cabinet with the supplied screws (3).

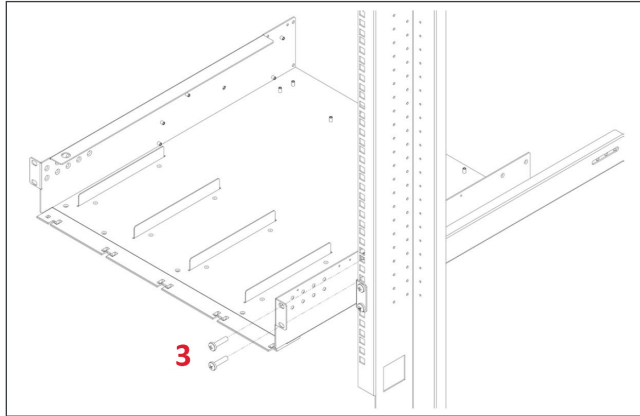

Fix cage nuts (4) in the mounting frame.

Slide the shelf in position and fix the shelf with the supplied screws (3).

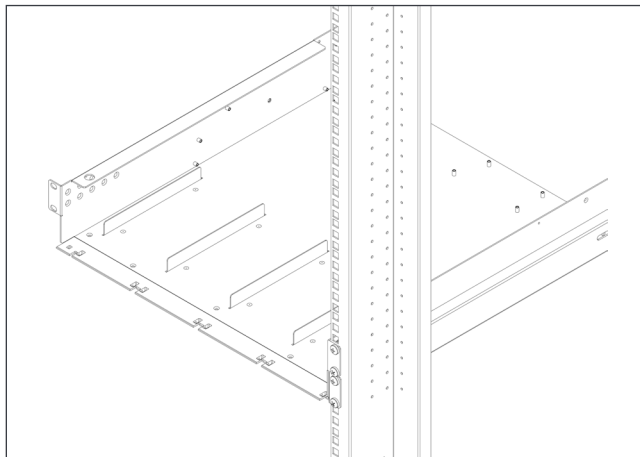

Finished.

8.2 Electrical installation for Bravo 25 shelf

8.2.1 Pre requisites

- The sub-rack have markings for all terminations.
- All cables shall be rated at Min 90 deg C.
- Electrical terminations shall be tightened with 5Nm.
- All connection screws are M5 x 12 mm.
- DC Input-Individual (per module), observe polarity.
- AC Input / AC output-Common (per shelf), respect phases.
- Wire all positions in the sub-rack for future expansion.
- Input AC / Output AC / Input DC / Signal cables shall be separated.
- Cable crossings shall be done in 90 deg angles.

8.2.2 Bravo 25 - 230-277 Single-phase shelf - Terminations

The below images are termination details of Bravo 25 - 230-277 Vac shelves.

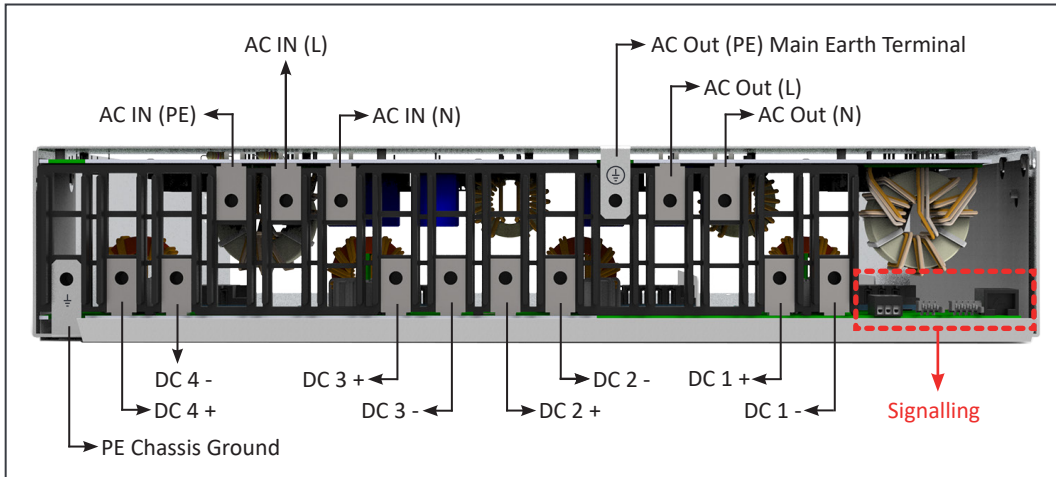

Bravo 25 - 48/230-277 - Shelf Rear Details

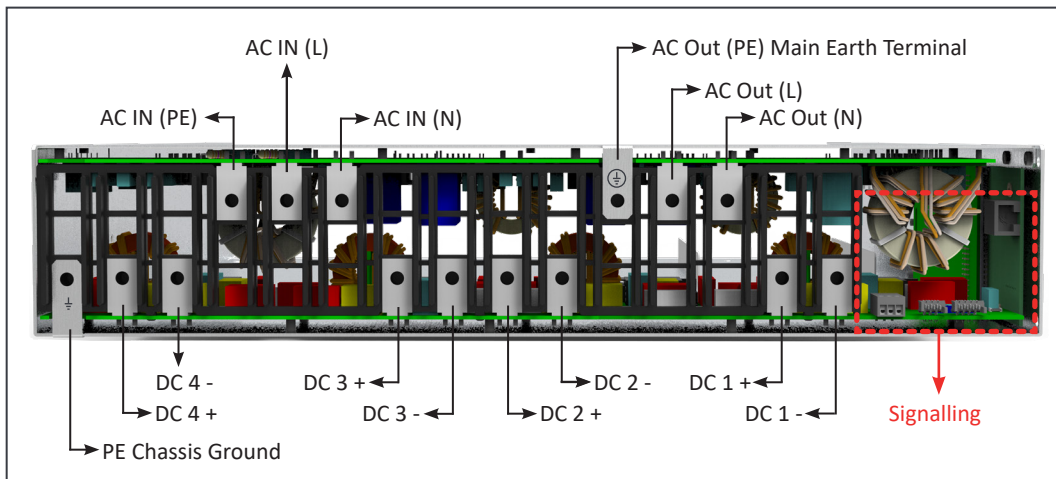

Bravo 25 - 110/230-277 - Shelf Rear Details

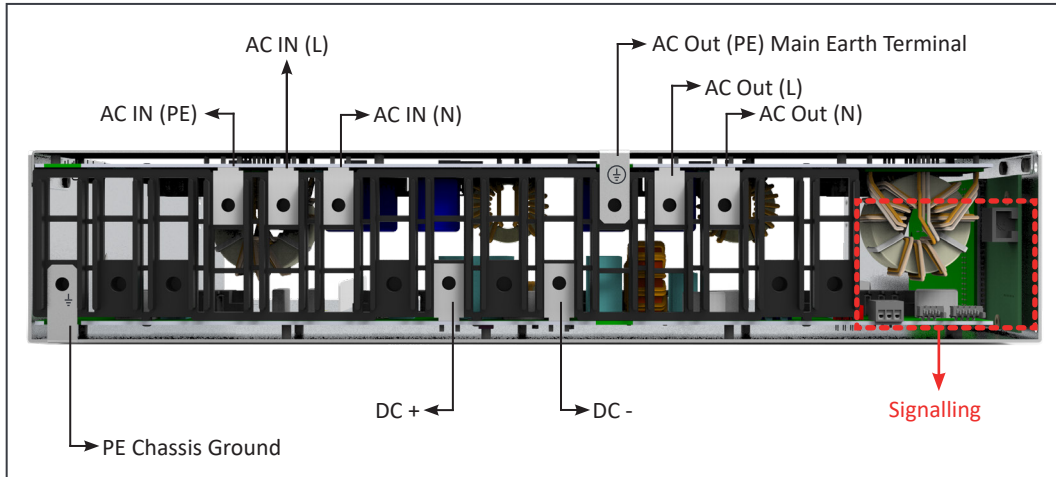

Bravo 25 - 380/230-277 - Shelf Rear Details

8.2.3 Bravo 25 - 230-277 Three-phase shelf - Terminations

Three-phase configuration is available in a single shelf.

Part number (48 Vdc) - T724830000

Part number (110 Vdc with isolation board for Inview) - T724850010

- Maximum three modules per shelf (9 kVA / 7.2 kW), and the first slot is a dummy module.
- Maximum two shelves can be paralleled, up to 18 kVA / 14.4 kW.
- Three individual DC Input.
- AC IN: 3 x 400 Vac + N (5 wires)
- AC OUT: 3 x 400 Vac + N (5 wires)
- DC: 48 Vdc and 110 Vdc

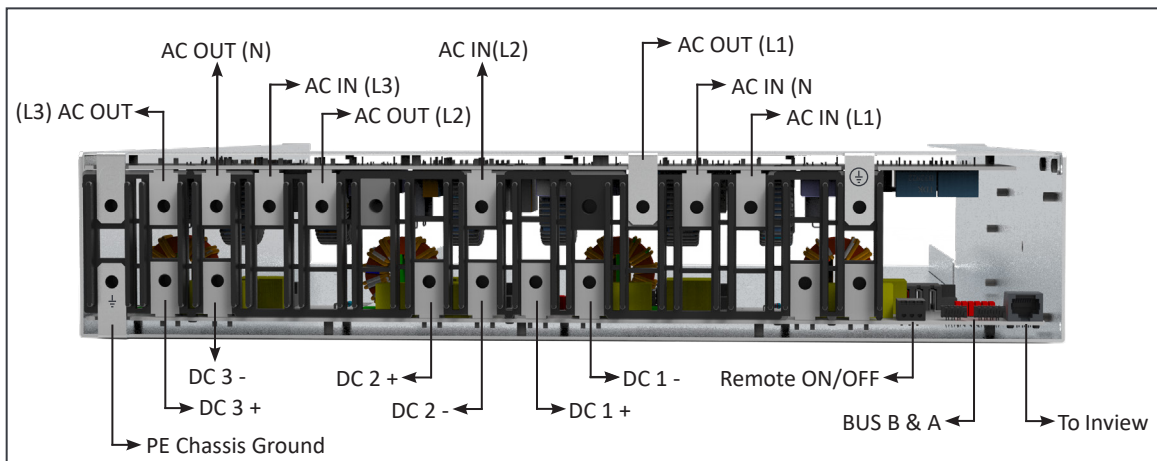

Bravo 25 - 48/230-277 - Three-Shelf Rear Details

8.2.4 Grounding

“PE CHASSIS GROUND” 

PE Chassis ground shall be wired to MET or distributed earth bar connected to MET, according to local regulations.

Warning!

The inverter module and shelves contain filters designed to protect against voltage surges and other disruptions. These filters have capacitors between L, N and earth (PE), which adds to the overall capacitance of the wiring system and the overall level of leakage current. Operation in the IT network may conduct to a high leakage current that needs to be monitored and controlled.

8.2.5 DC Connection

Model	MCB	Cable, min	Connector	Torque
Bravo 25 - 48/230-277	63 A per module	2 x 16 mm ²	M5	5 Nm
Bravo 25 - 110/230-277	32 A per module	2 x 6 mm ²	M5	5 Nm
Bravo 25 - 380/230-277	40 A per shelf	2 x 10 mm ²	M5	5 Nm

8.2.6 AC Input Connection

WARNING !!!

Recommendation of IEC 60364 4. 43

431.3 Disconnection and reconnection of the neutral conductor in multi-phase systems

Where disconnection of the neutral conductor is required, disconnection and reconnection shall be such that the neutral conductor shall not be disconnected before the line conductors and shall be reconnected at the same time as or before the line conductors.

RCD Recommendation

This equipment contains EMI/EMC filter, which generates a leakage current below 3.5 mA per inverter in conformity with EN62040-1 safety standard. If an RCD device needs to be installed, it should be placed at the AC output of the equipment.

Model	MCB per shelf	Cable, min	Connector	Torque
Bravo 25 - 48/230-277	2P 63 A	3 x 16 mm ²	M5	5 Nm
Bravo 25 - 110/230-277				
Bravo 25 - 380/230-277				

Note: Icc value measured as 75 A_{rms} per shelf with four modules.

8.2.7 AC Output Connection

Model	MCB per shelf	Cable, min	Connector	Torque
Bravo 25 - 48/230-277	2P 63 A	3 x 16 mm ²	M5	5 Nm
Bravo 25 - 110/230-277				
Bravo 25 - 380/230-277				

8.2.8 Signalling

8.2.8.1 Bravo 25 - 48/230-277

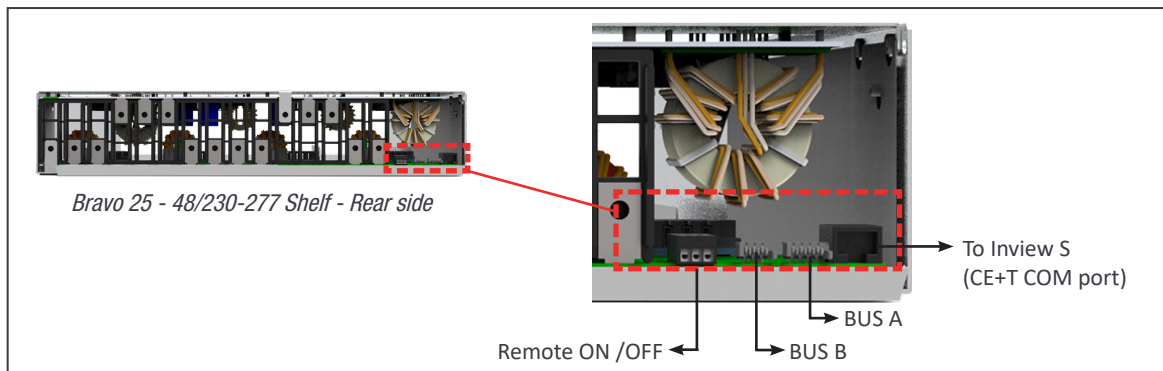

8.2.8.2 Bravo 25 - 110/230-277 and Bravo 25 - 380/230-277

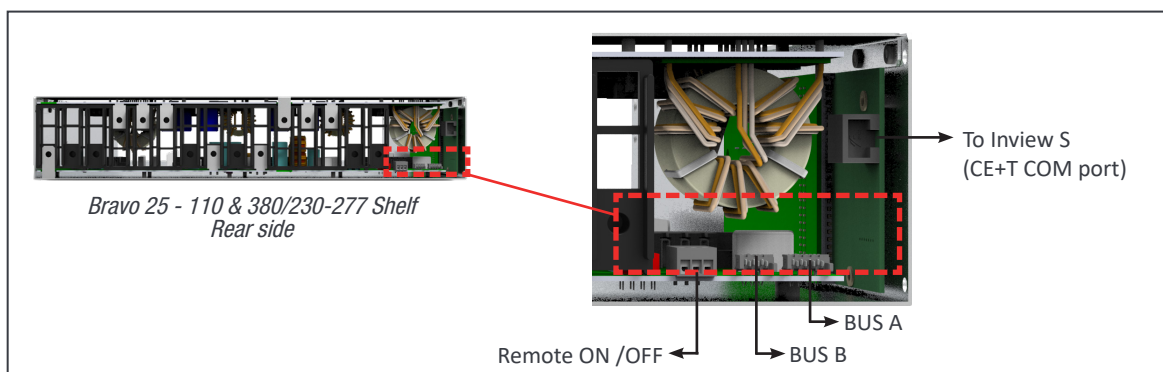

8.2.9 Remote ON/OFF

The function of remote ON/OFF is used to turn off the module/system output.

By default a jumper is placed between pin 3 and 2. If remote on/off is used, the jumper should be removed from the shelf and connect the changeover contactor.

- AC and DC inputs are not affected by the remote ON/OFF function.
- The remote ON/OFF can be connected to any shelf.
- The remote ON/OFF requires a changeover contactor, one input opens as the other closes. If both transitions are not picked up, the status is not changed.

Relay characteristics (Remote ON/OFF)

- Signal voltage +5 VDC (galvanic insulated)
- Max wire size 1 mm²

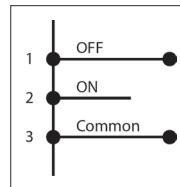

Functional table for remote ON/OFF function

#	Pin 1-3	Pin 2-3	Status	Indication
1	Open	Open	Normal operation	All (Green)
2	Closed	Open	OFF	AC output (OFF) AC Input (Green) DC Input (Green)
3	Open	Closed	Normal operation	All (Green)
4	Closed	Closed	Normal operation	All (Green)

Warning: If remote ON/OFF is not used, pin 2 and 3 MUST be bridged together!

8.2.10 Internal BUS A and B

- In A la Carte systems the internal Bus is pre-installed.
- The internal bus consists of 6 and 8 pin ribbon cables.
- The internal bus connectors are sensitive and special caution should be taken during installation to keep them out of harm's way.
- The internal bus is connected from the first shelf to the last shelf.

8.2.11 Shelf rear cover

The rear cover provides IP20 protection for the terminations at the backside of the shelf. It is optional, and you can order it separately.

- The rear cover is snapped into position in the rear of the sub-rack.
- Remove material using a pair of side cutters to allow cable entry and exit.

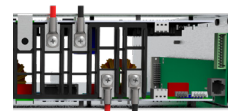

Connect the cables.

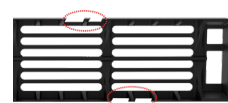

Cut appropriate size on the protection cover for cable access.



Fix the protection cover at the rear side of the shelf.

9. Installation of Cabinet (A la Carte)

9.1 Unpacking the system

CE+T cabinets are always fixed on a pallet, and then packed in a wooden crate.

These crates are usually delivered laying flat, horizontally.

To unpack your cabinet, we recommend the following method:

1. Make sure that the crate is laying flat, with the correct side up. This side is identified by a double red arrow.
2. Remove the top cover in order to be able to identify the top and bottom sides of the cabinet.
3. Raise the crate vertically with the top side of the cabinet up. Make sure that the cabinet does not fall forward out of the crate while you do so.
4. Remove the cabinet and its attached pallet from the crate.

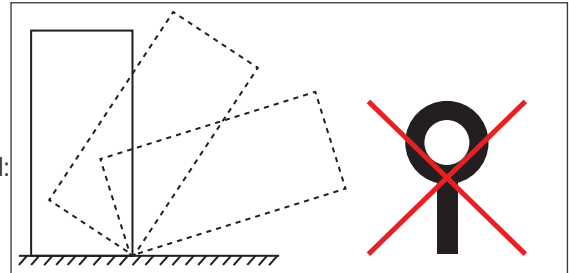

If you prefer to take the wooden crate apart before raising the cabinet, make sure you do not damage or dent the cabinet while doing so.

Warning: The top cover fixing bolts may NEVER be replaced with lifting eye bolts.

9.2 Module Packing

When inverters are ordered **together with a system**, they are either delivered in the cabinet or on a separate pallet.

- If you find the inverters in the cabinet: you need to remove them in order to raise the cabinet more easily, **but before you do so make sure to have identified in which slot was each module. Indeed, it is important to replace each module in the same slot** it was delivered in!
- If the modules have been delivered separately, in carton on pallet, they will be clearly identified in order to be placed in the right slot.
- It is important to place the modules in the right slot, as this will ensure that the addressing of each module in the config file corresponds to the physical slot. Without this, the system will of course function properly but you might find it difficult to identify on which modules your applying changes you would be bringing to the config file.
- Also, in 3 phase systems, replacing modules configured to function in a specific phase in a slot assigned to another phase will result in the module to be un-synchronized. Your system may not start and you will have to reconfigure manually each module that was misplaced.

If you ordered modules only:

- If they are meant to be used in running systems or in a not operational single phase system, you may insert them in any slot.
- If they are meant to be placed in a not yet started 3 Phase system, follow these steps:
 - Insert one module per phase.
 - Start the system according to the start-up and commissioning procedure.
 - Insert the remaining modules progressively.
 - Module packing material shall be taken apart.

9.3 Removing the cabinet rear protection

Wooden wedges are fixed at the back of the cabinet to prevent parts from moving and sustaining damage during transportation. These wooden wedges must be removed before going further with the cabinet's installation and commissioning.

1. Remove the rear panel.
2. Identify the protection (see the following figure).
3. Cut the tie wraps holding the back wedges and remove them.

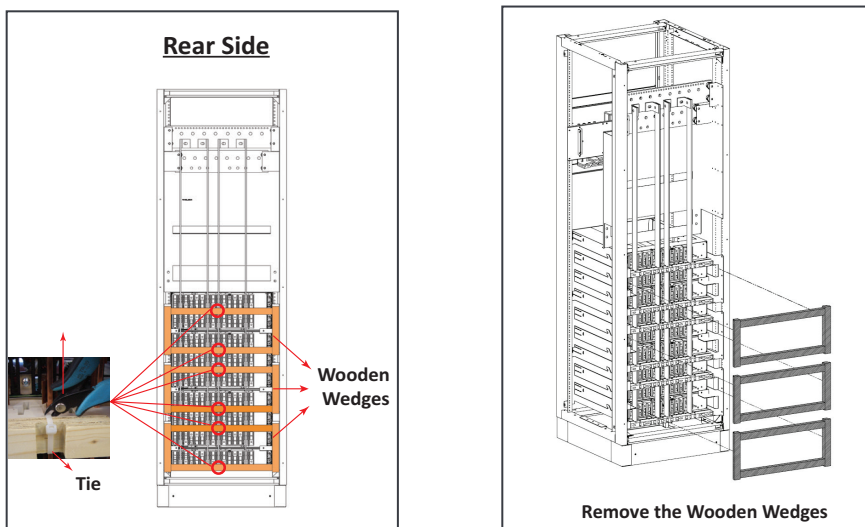

9.4 Hardware Connections

In Bravo 25 inverter system, the Inview S and Measure Box Battery should be connected as per the following:

1. Connect "RJ45" port in shelf and "CE+T COM" port in Inview S using RJ45 straight cable.
2. Connect 12 V supply to Inview S from auxiliary power supply kit.

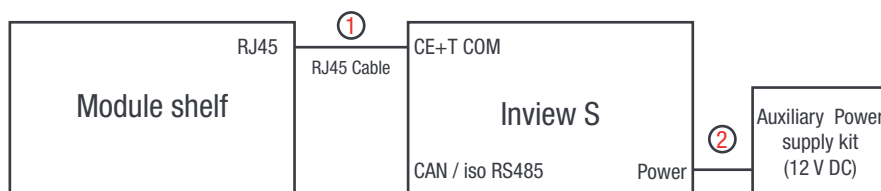

9.5 Electrical Installation

- All cables shall be halogen free and rated min 90 deg C.
- Wire all positions for future expansion.
- Input AC / Output AC / Input DC / Signal cables shall be separated.
- Cable crossings shall be made at 90 deg angles.
- Empty module positions shall be covered with blank module or cover.

9.5.1 Positioning

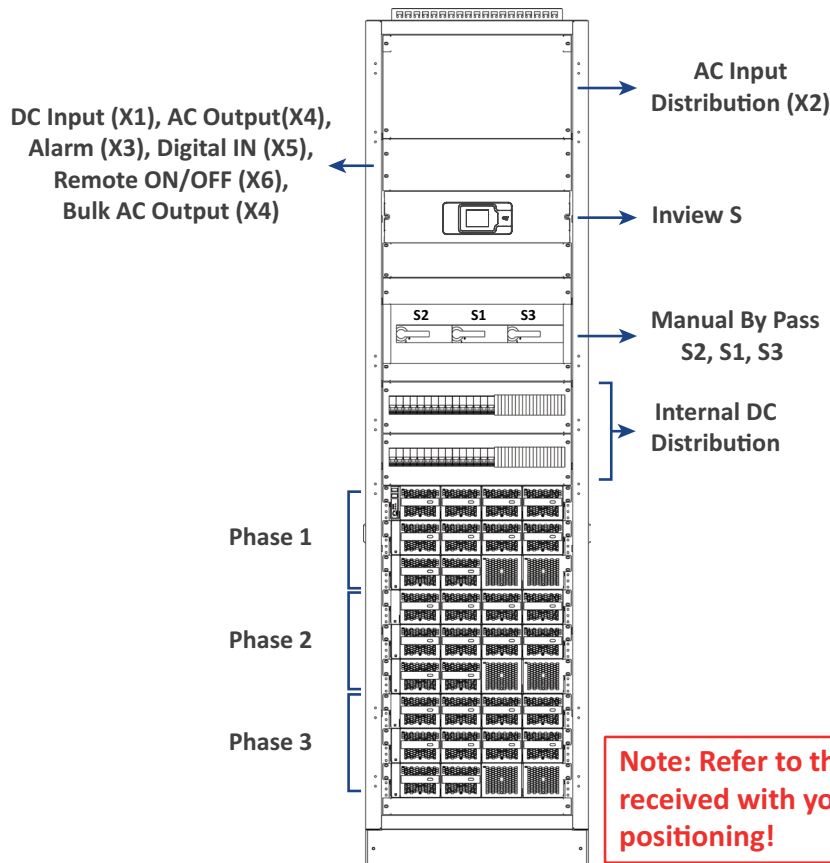

9.5.2 Cabling

All the cable routings are made through top or bottom of the system. The top cover can be split into two parts to facilitate cabling. The top cover accommodates nylon tie straps used to strap the cables.

Note: Do not block the airflow at top of the cabinet.

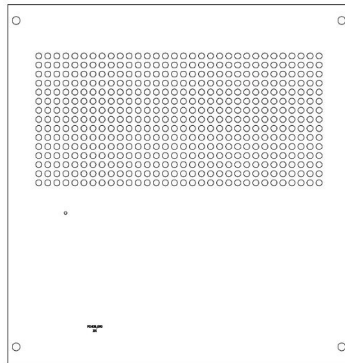

Top plate - Type I

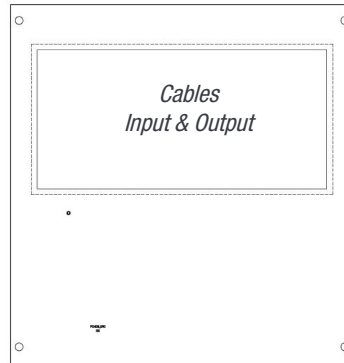

Top plate - Type II

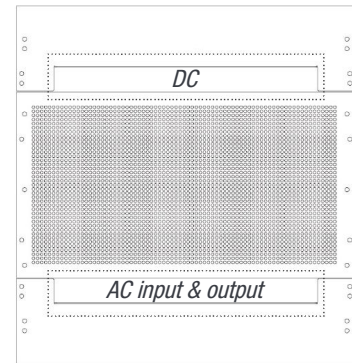

Top plate - Type III

9.5.3 Grounding

Ground terminals are located in the top rear left corner, labelled "PE CHASSIS GROUND". 

PE Chassis ground shall be wired to MET or distributed earth bar (MET). Ground must be terminated even if commercial mains is not available. According to local regulations, min 16 mm².

Warning!

The inverter module and shelves contain filters designed to protect against voltage surges and other disruptions. These filters have capacitors between L, N and earth (PE), which adds to the overall capacitance of the wiring system and the overall level of leakage current. Operation in the IT network may conduct to a high leakage current that needs to be monitored and controlled.

9.5.4 Surge Suppression

The mains (AC) supply of the modular inverter system shall be fitted with suitable Lightning surge suppression and Transient voltage surge suppression for the application at hand. Manufacturer's recommendations of installation shall be adhered. It is advisory to select device with alarm relay for function failure.

Indoor sites are considered to have a working lightning surge suppression device in service.

- Indoor sites: Min Class II.
- Outdoor sites: Min Class I + Class II or combined Class I+II.

9.5.5 AC Input (X2) and Output (X4)

WARNING !!!

Recommendation of IEC 60364 4. 43

431.3 Disconnection and reconnection of the neutral conductor in multi-phase systems

Where disconnection of the neutral conductor is required, disconnection and reconnection shall be such that the neutral conductor shall not be disconnected before the line conductors and shall be reconnected at the same time as or before the line conductors.

RCD Recommendation

This equipment contains EMI/EMC filter, which generates a leakage current below 3.5 mA per inverter in conformity with EN62040-1 safety standard. If an RCD device needs to be installed, it should be placed at the AC output of the equipment.

WARNING !!!

Input Neutral is required to operate the Inverter, UPS

In TN-S System no 4 pole input switch or circuit breaker shall be used. If you have to use 4 pole protective device, be aware that the neutral against the ground is floating. The inverter, UPS will operate without problem but you may infringe the local regulation.

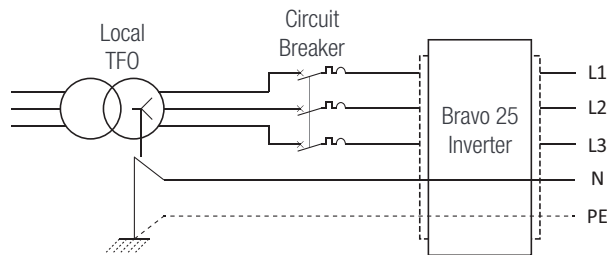

The AC input is wired to a screw terminal. Max cable area is 180 mm²

9.5.5.1 Single phase

L N PE

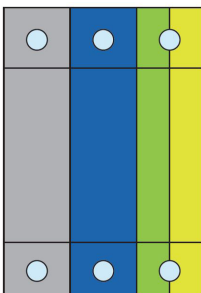

9.5.5.2 Three phase

The three phase input is 123, ABC, RST phase sensitive; clockwise rotation is recommended. Phase one starts at 0° phase shift, while the other phases will be at -120° phase shift and + 120° phase shift resulting in three phase output.

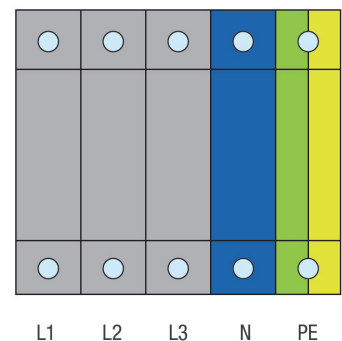

9.5.6 DC (X1)

- Common DC input per system.
- M12 holes in bar.
- Max 8 x 240 mm² per pole (group).

Note: Screws and nuts are not included in the delivery.

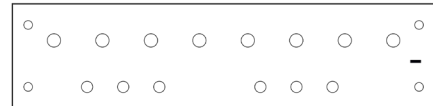
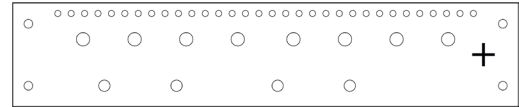

9.5.7 Connection table – DC 48 Vdc (X1)

Power (kVA)		DC	
1ph	3ph	Fuse/CB	Min Cable mm ²
12	36	250 A	120
24		500 A	240
36		800 A	2 x 240
48	72	1000 A	4 x 150
60		1250 A	3 x 240
72		2 X 800 A	4 x 240
84	90	2 X 1000 A	8 x 150
96		2 X 1000 A	8 x 150
		2 X 1000 A	8 x 150

9.5.8 Connection table – DC 110 Vdc (X1)

Power (kVA)		DC	
1ph	3ph	Fuse/CB	Min Cable mm ²
12	36	125 A	50
24		250 A	120
36		400 A	180
48	72	630 A	2 x 150
60		630 A	2 x 180
72		800 A	2 x 240
84	90	1000 A	4 x 150
96		1000 A	4 x 150
		1000 A	4 x 150

9.5.9 Connection table – DC 380 Vdc (X1)

Power (kVA)		DC	
1ph	3ph	Fuse/CB	Min Cable mm ²
12		50 A	16
24		100 A	35
36		160 A	70
	36		
48		200 A	95
60		250 A	120
72		300 A	150
	72		
84		300 A	150
	90	355 A	180
96		355 A	180

9.5.10 Connection table – AC Input (X2) & Output (X4)

The AC input supply breaker shall be 2p for single phase, and minimum 3p for three phase.

Power (kVA)		AC Input & Output (Screw terminal)		
1ph	3ph	Calculated	Fuse/CB	Min. Cable mm ²
12		52.5 A	63 A	16
24		105 A	125 A	35
36		157 A	160 A	70
	36	3 x 52.5 A	3 x 63 A	3 x 16
48		210 A	250 A	95
60		262.5 A	300 A	150
72		315 A	350 A	180
	72	3 x 105 A	3 x 125 A	3 x 35
84		370 A	400 A	180
	90	3 x 131 A	3 x 160 A	3 x 70
96		420 A	630 A	2 x 180

9.5.11 Signalling

The illustration below shows the X3 relays contacts in a non-alarm state when the system is operational. In this case, the relays are energized and as below.

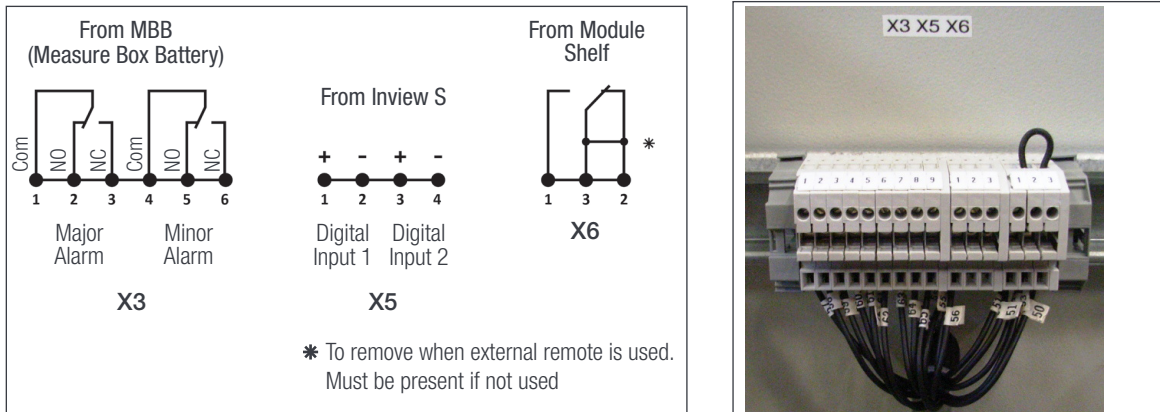

When an alarm occurs, the X3 relay contacts are de-energized and switch.

Note: For auxiliary connections from MBP, refer section 13.2, page 54.

9.5.11.1 Alarm (X3)

Relay characteristics X3 (Major and Minor Alarm)

- Switching power 60 W
- Rating 2 A at 30 Vdc / 1 A at 60 Vdc
- Max wire size 1 mm²

9.5.11.2 Digital In (X5)

Input characteristics X5 (Digital Input 1 and 2)

- Signal voltage +5 Vdc (galvanically insulated)
- Max wire size 1 mm²

9.5.11.3 Remote ON/OFF (X6)

The function of remote ON/OFF is used turn off the module/system output.

By default a jumper is placed between pin 3 and 2. If remote on/off is used, jumper should be removed from the shelf and connect changeover contactor.

- AC and DC inputs are not affected by the remote ON/OFF function.
- The remote ON/OFF can be connected to any shelf.
- The remote ON/OFF requires changeover contactor, one input opens as the other close. If both transitions are not picked up the status is not changed.
- Digital input characteristics (Remote ON/OFF)
 - Signal voltage +5 VDC (galvanically insulated)
 - Max wire size 1 mm²

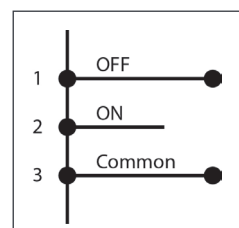

Functional table for remote ON/OFF function

#	Pin 1-3	Pin 2-3	Status	Indication
1	Open	Open	Normal operation	All (Green)
2	Closed	Open	OFF	AC output (OFF) AC Input (Green) DC Input (Green)
3	Open	Closed	Normal operation	All (Green)
4	Closed	Closed	Normal operation	All (Green)

Warning: If remote ON/OFF not used, pin 2 and 3 MUST be bridged together!

10. Operation

10.1 Inverter module

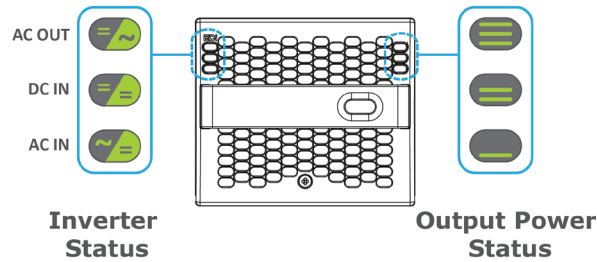

Inverter Status LED	Description	Remedial action
OFF	No input power or forced stop	Check environment
Permanent green	Operation	
Blinking green	Inverter OK but working conditions are not fulfilled to operate properly	
Blinking green/orange alternatively	Recovery mode after boost (10 In short circuit condition)	
Permanent orange	Starting mode	
Blinking orange	Modules cannot start	Check Inview
Blinking red	Recoverable fault	
Permanent red	Non recoverable fault	Send module back for repair



Output Power (redundancy not counted)						
<5%	5% to 40%	40 to 70%	80 to 95%	100%	100% = overload	Output Power (redundancy not counted)
×	×	×	≡	≡	≡	Status output power LED
×	×	=	=	=	=	
—	—	—	×	—	—	
1B	1P	2P	2P	3P	3B	Behaviour (B = Blinking, P = Permanent)

10.2 Inview S - LCD Interface

Inview S LCD interface is a 2.8-inch touch screen. It does not have any user account, the user can only view the system details. The LCD interface is protected with the PIN during any action request.

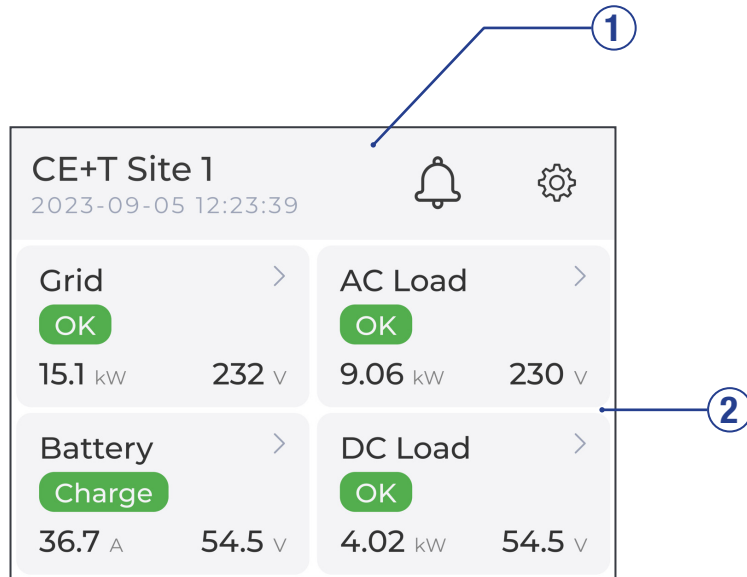
Once system is powered upon, the Inview S is up and ready for operation.



- **[1] Header:** Displays the Site name, Date and Time.
 - **Events:** Tapping on  goes to Alarms and Events screen.
 - **Administration:** Tapping on  provide access to different action screens.
- **[2] Interface Area:** Tapping on the widget provides the corresponding parameter information. Provides information about the corresponding screen. In some screens, left and right navigation buttons appear, indicating more screens are present.
- **Navigation arrows** for the next and previous pages. Up and down arrows appear on some screens, indicating more information is present.

10.2.1 LED Indications

Three LED's are present at front side of the controller to indicate major alarm, minor alarm, and system status.

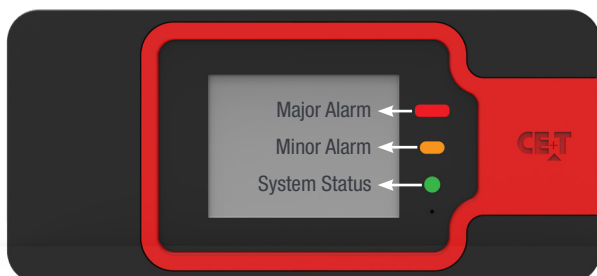

10.2.2 Menu Structure

The below tree provides an overview of the menu structure in the Inview S LCD interface.

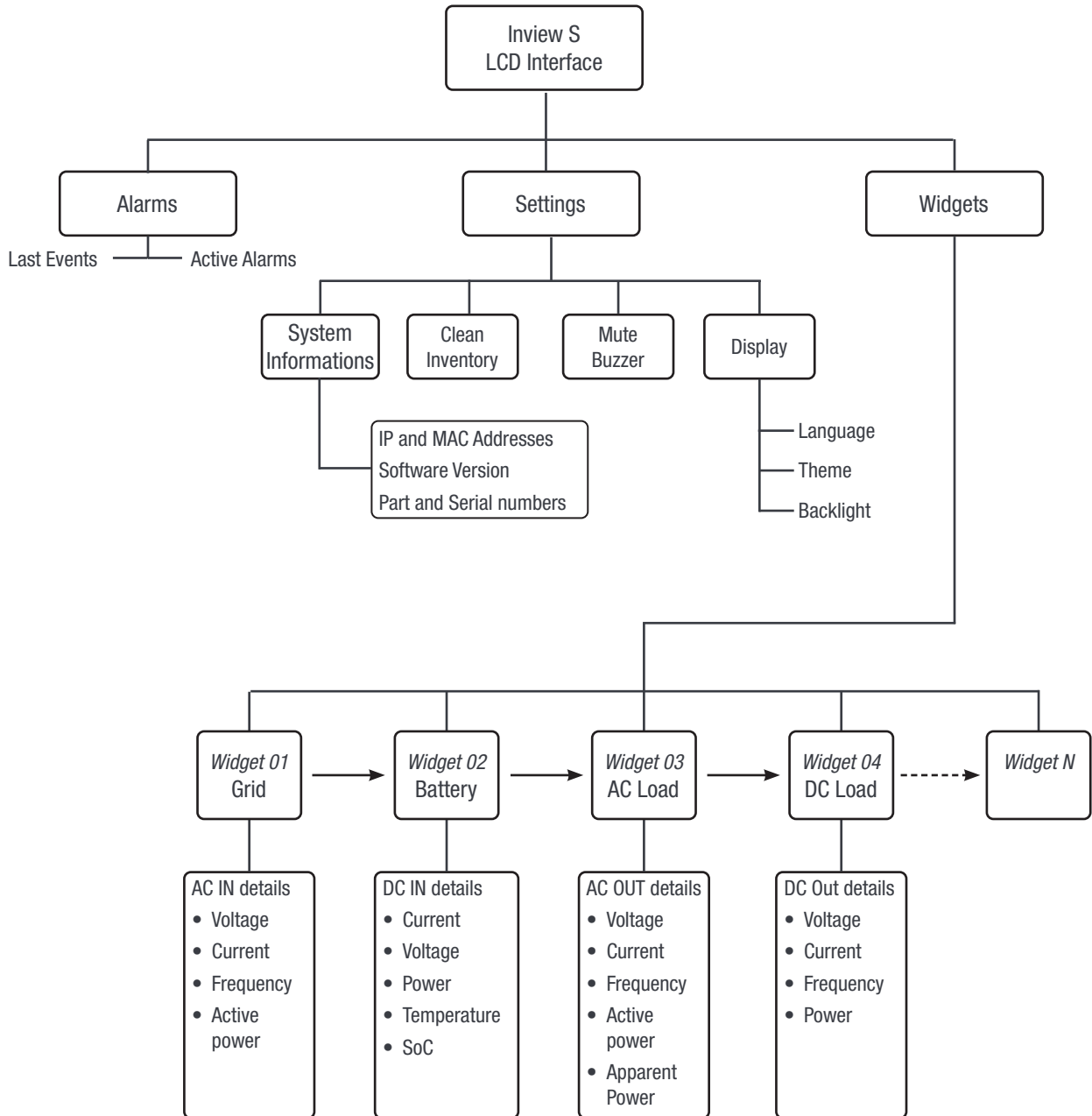



10.3 Inview X - LCD Interface

Inview X LCD interface is a 7-inch touch screen. Through the LCD interface, the user can view and access the system details. Once the system is powered upon, the Inview X is up and ready for operation.

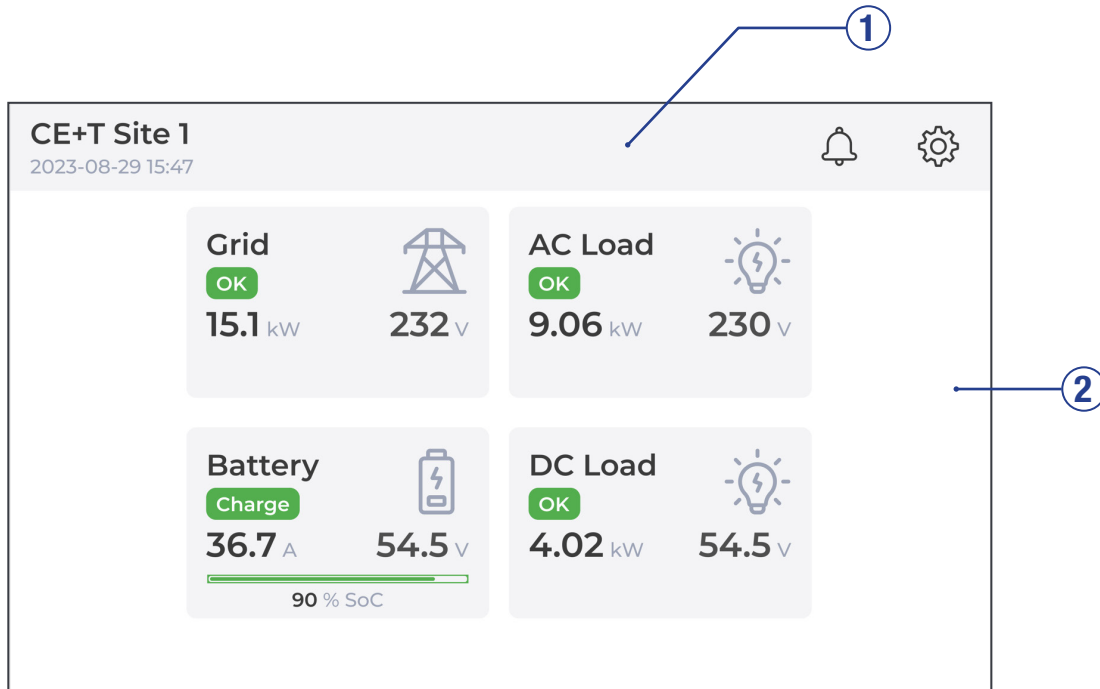
Note: Interface graphics and layout may change based on firmware version.



- **[1] Header:** Displays the Site name, Date and Time.
 - **Events:** Tapping on  goes to Alarms and Events screen.
 - **Administration:** Tapping on  provide access to different action screens.
- **[2] Interface Area:** Tapping on the widget provides the corresponding parameter information. Provides information about the corresponding screen. In some screens, left and right navigation buttons appear, indicating more screens are present.
- **Navigation arrows** for the next and previous pages. Up and down arrows appear on some screens, indicating more information is present.

10.3.1 Menu Structure

The below tree provides an overview of the menu structure in the Inview X LCD interface.

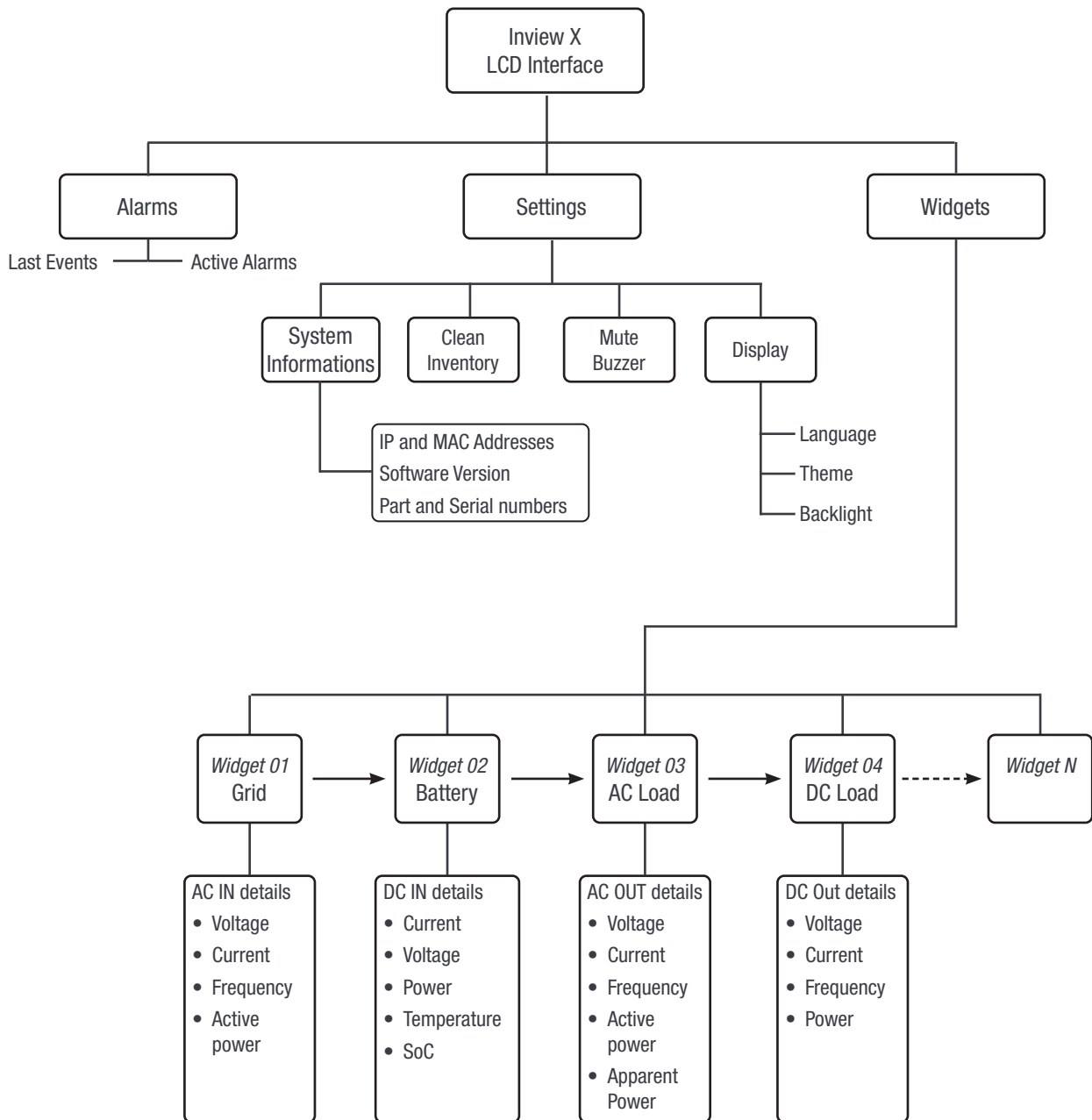

10.3.2 LED Indications

Three LED's are present behind the front white plastic of the controller to indicate major alarm, minor alarm, and system status. These LED's are not visible until they illuminate during the corresponding action occurs.

Light Blue: Normal Operation

Orange: Minor Alarm

Red: Major Alarm



10.4 LCD interface - Terminology

The below table provides the description of terminology which appears in Inview Slot, S and X LCD interface.

S.NO	Terminology	Description
1	Clean Inventory	The controller performs a complete scan and remove the non-active inverters from the inverter list. <i>Note: If any parameter is changed, an authentication page appears. Enter the display PIN password to apply changes.</i>
2	Mute buzzer	Buzzer sound will be muted
3	Logs	Display the latest 100 events occurred.
4	System Information	Displays product, network and software details

10.5 Inview S and X - Web Interface

The web interface of all the controller **Inview Slot, S** and **X** is same. The Inview web interface provides the user to interact with system, access, configure and modify the system parameters.

The below tree provides an overview of the menu structure in the web interface.

Note: Widgets varies depending upon the topology selection.

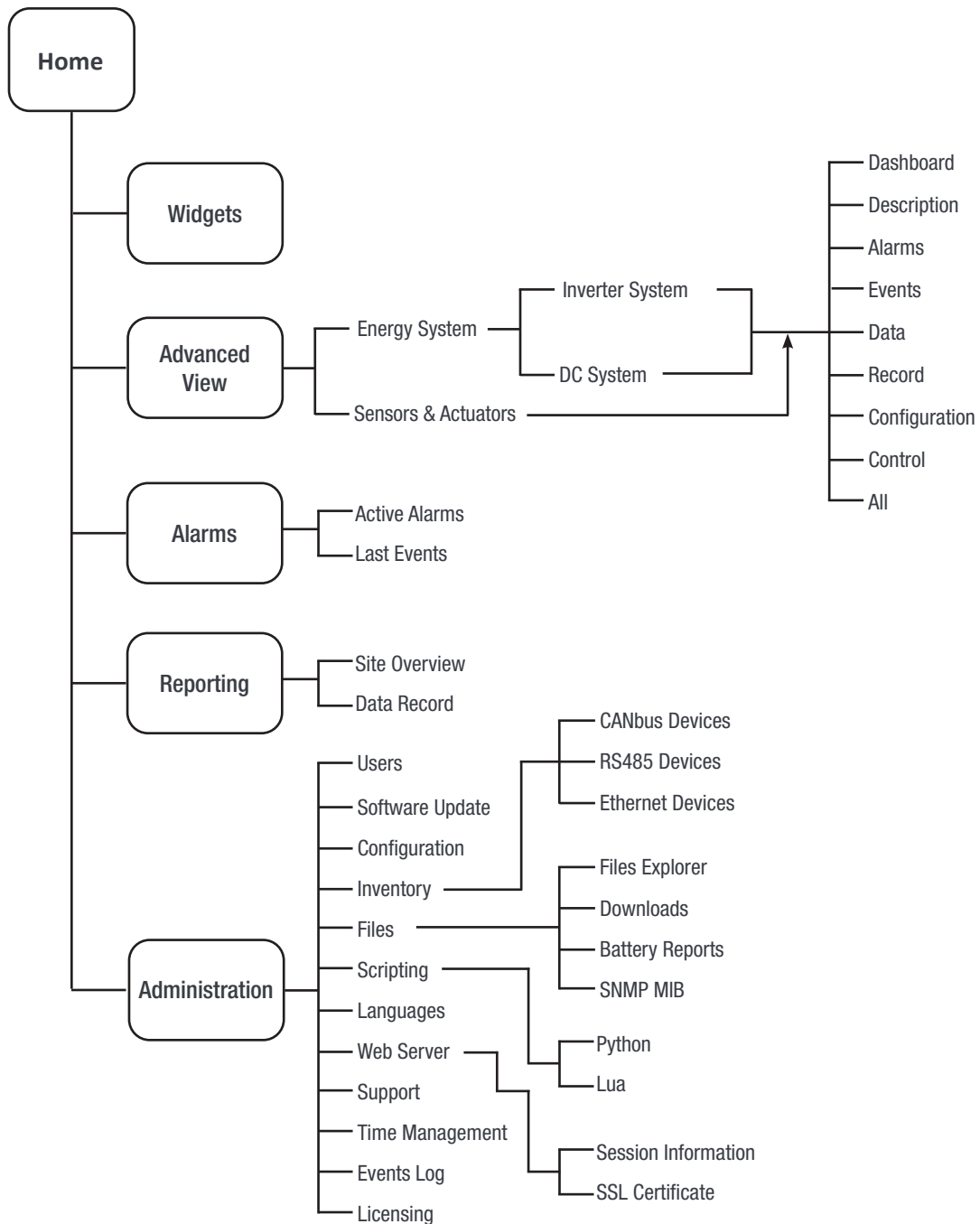

10.5.1 Login

Once system is powered on, the Inview Slot/S and X is up and ready for operation. Configuration and other parameters can be changed using the web interface. Perform the following procedure to configure the system through web interface.

Open the web browser and type the default IP address **10.250.250.1** in the address field and press enter.

Note: Use any one of the following latest web browsers: Google Chrome, Mozilla Firefox, Safari, or Microsoft Edge.

Inview Slot, S, X and XC have three login – Basic, Expert and Admin. All three login is password protected.

The default password for all three logins is “1234”.

Basic login can only browse the pages and download the files, but **Expert** and **Admin** login can access and also modify the system parameter values.

An auto-logout feature is available to avoid a user being connected all the time. When no action is performed for more than **10 minutes**, the session will expire and goes to login screen.

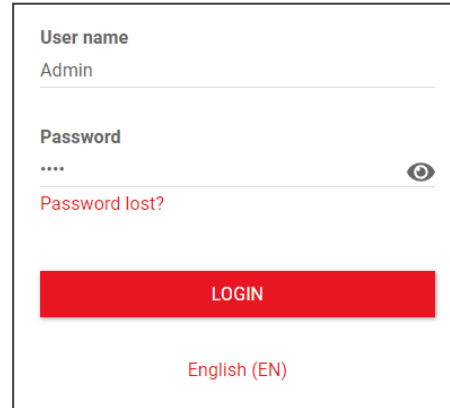

10.5.2 Interface Areas

- 1 → Header
- 2 → Home Page

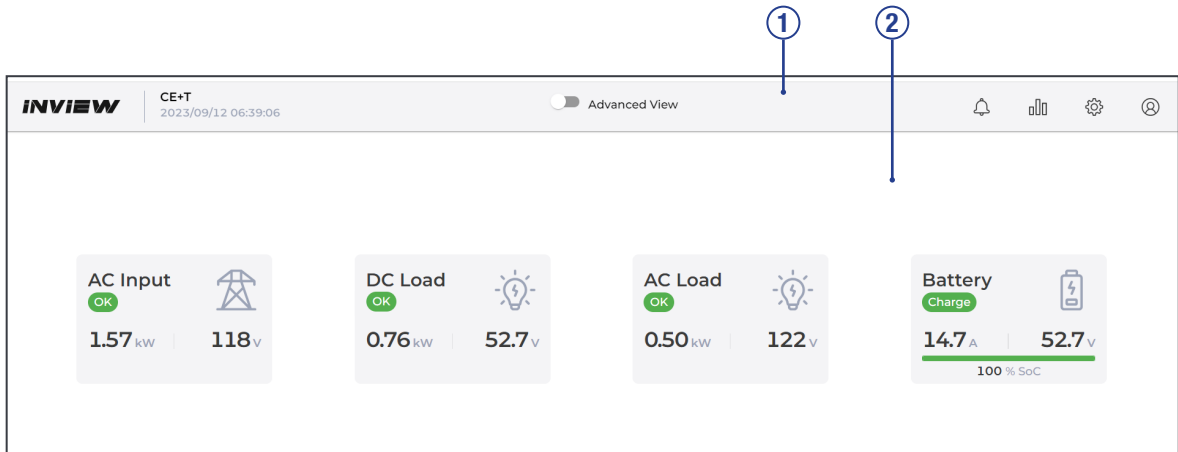



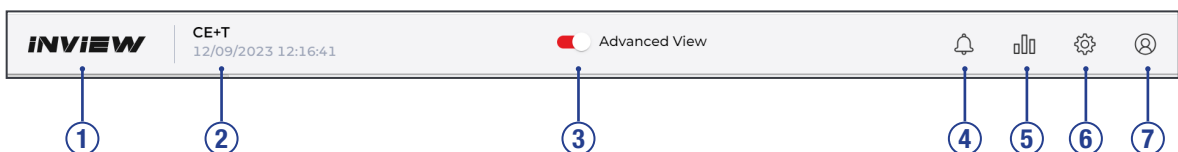

10.5.2.1 Header

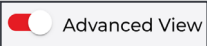

The icons on the header provide quick access to the corresponding pages.

- 1 → **Home:** Clicking on **INVIEW** logo goes to the home page from any page you are accessing in the interface.

- 2 → Display the date, time and site name of the system.
- 3 → **Configuration:** Click on  to toggle between Configuration and Widget or Dashboard page.
- 4 → **Alarms:** Clicking on  goes to the Alarm page, where active alarms and last events are listed.
- 5 → **Reporting:** Clicking on  goes to Reporting page, where Data records and Site details are available.
- 6 → **Administration:** Clicking on  goes to the Administration page and provides access to many action pages such as User management, Software update, Configuration files, Reports, References, Languages selection, Support package, Time management, Events log and Licensing.
- 7 → **User Context:** Clicking on  provides the information of login account such as Basic, Expert or Admin, Quick Links to Save Configuration and reboot controller, Website links to download software and documents, Device and network information, Change Password and Logout.

10.5.2.2 Home Page

The default home page is Widgets to display system information briefly. On the Widgets home page, a maximum of 20 widgets can be configured.

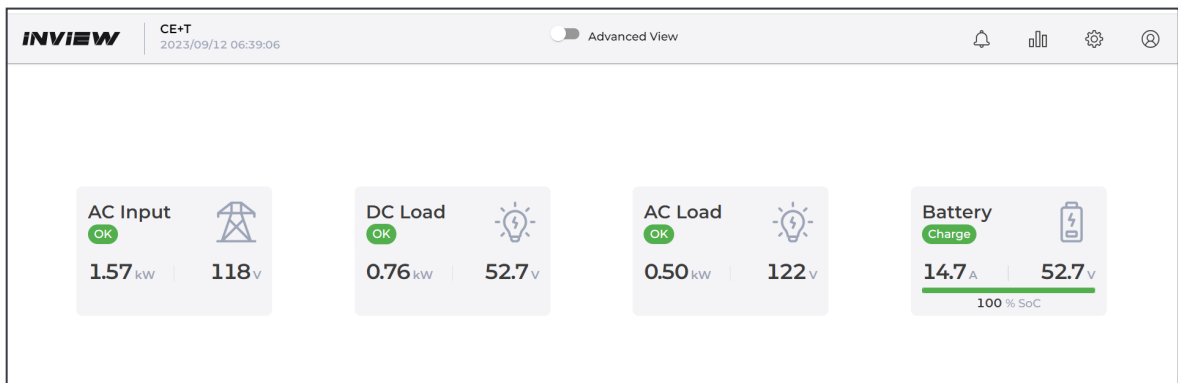

Clicking on any widget displays the corresponding details on right side of the page.

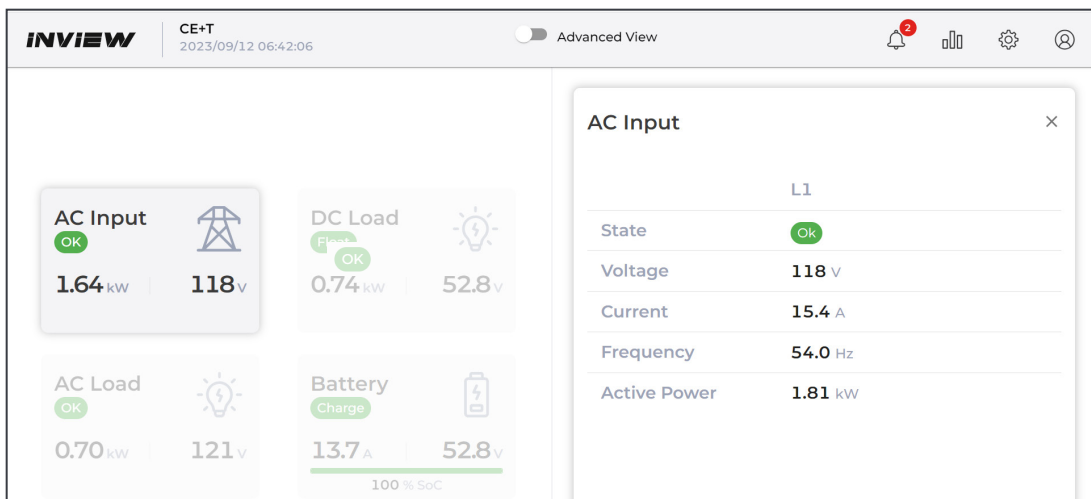

10.5.3 Widgets

The Inview widgets are identical for the web interface and LCD touch screens. The flexible view can be configured depending on the system topology with the following types of widgets:

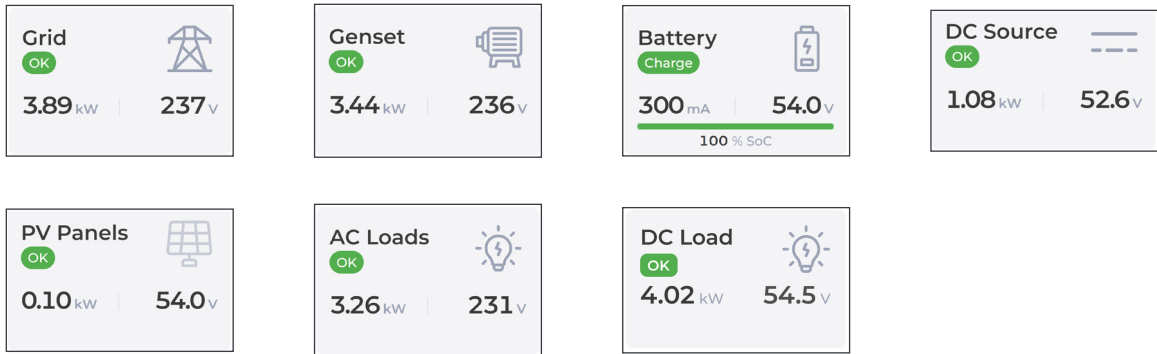











Source and Load are the different convention signs used for the different assets. The conventions of the different assets are listed in the below table. Based on the type of asset, the widget icon is displayed on the home page.

S.No	Widget	Convention Type	Power Supplied	Power Received
1	Grid	Source	Positive	Negative
2	Genset	Source	Positive	Negative
3	Battery	Load	Negative	Positive
4	DC Source	Source	Positive	Negative
5	Solar	Source	Positive	Negative
6	AC Load	Load	Negative	Positive
7	DC Load	Load	Negative	Positive



10.6 Web page Controls

Placing or clicking on it performs the corresponding action.

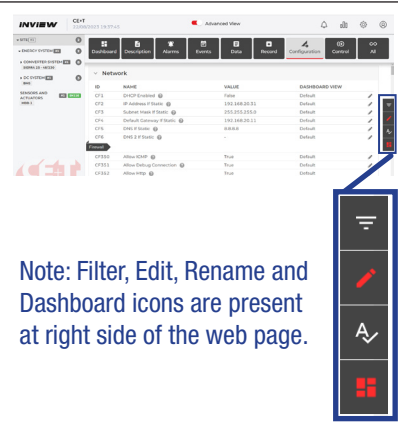
Controls	Description
	Filters: Page displays depending upon the filter selection.
	Page changes to edit mode and the user can change the parameters. If any parameter value is changed, the edit icon changes to modification icon and displays the list.
	Rename the parameter name.
	Select the corresponding parameter to either display or not on the Dashboard tab of the Advanced View page.
	On-Board help: Provide a short description to help to know about the corresponding parameters.
	Page or section expands
	Page or section collapse
	Particular section opens in a new tab
	Particular section open as a pop-up
	Drop down list – more options are present
	Delete / Clear the corresponding parameter.

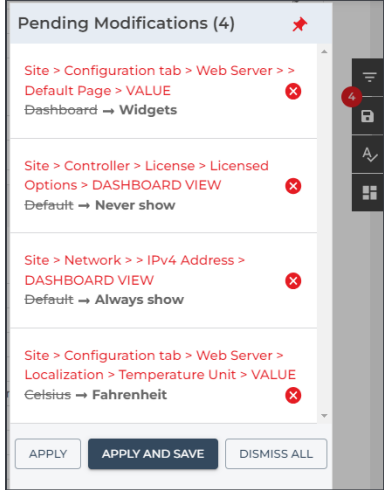

Note: Filter, Edit, Rename and Dashboard icons are present at right side of the web page.

Controls	Description
	<p>Modifications list: It appears at right side of the “Advanced View” page. This list helps the user to overview the changes and can apply the required parameters.</p> <p>Apply: Clicking on “APPLY” button, the controller accepts all the parameter changes in the modifications list.</p> <p>Apply and Save: Clicking on “APPLY AND SAVE” button, the controller accepts all the parameter changes in the modifications list and saves them in the configuration file.</p> <p>Dismiss All: Clicking on “DISMISS ALL” button, the controller rejects all the parameter changes in the modifications list.</p> <p>Clicking on  button, the controller rejects only the particular modification from the list.</p> <p>Note: The number on the icon indicates the number of modifications in the list.</p> 

Note: To know more about Inview S and X operation, and module parameter list, refer to the Inview manual and it is available on the CE+T website.

11. Inserting/removing/replacing - modules

11.1 Bravo 25 Inverter

- The Bravo 25 inverter is hot swappable.
- When a new module is inserted in a live system it automatically takes the working set of parameters.
- When a new module is inserted in a live system it is automatically assigned to the next available address.

Caution: After removing a module from a slot in a live system, wait at least 60 seconds before inserting it into another slot; ensure that the LEDs are off and the fan is completely stopped.

11.1.1 Removal

Caution: When one or several inverter modules is/are removed, possible to access the live parts. So, replace the module(s) with blanks without delay.

1. Rotate the screw in anti clockwise by using cross head screw driver to unlock the latch.
2. Hold the front handle and pull the module out.
3. Replace with a new module or a blind unit.

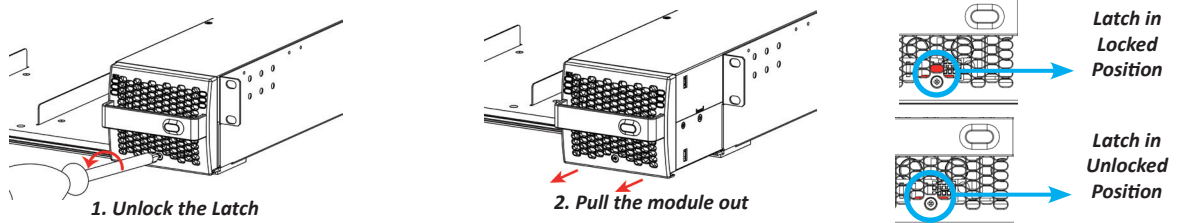

11.1.2 Inserting

1. Check module compatibility (DC Voltage!).
2. Place the module in the shelf and slide in.

Caution: Make sure that the module is oriented and locked properly into the shelf. Module not properly inserted and locked might cause damage due to improper electrical connection.

3. Using the module handle, push firmly until the unit is properly connected.
4. Rotate the screw in clockwise by using cross head screw driver to lock the latch.
5. The module will start up and take the first address available on the bus.

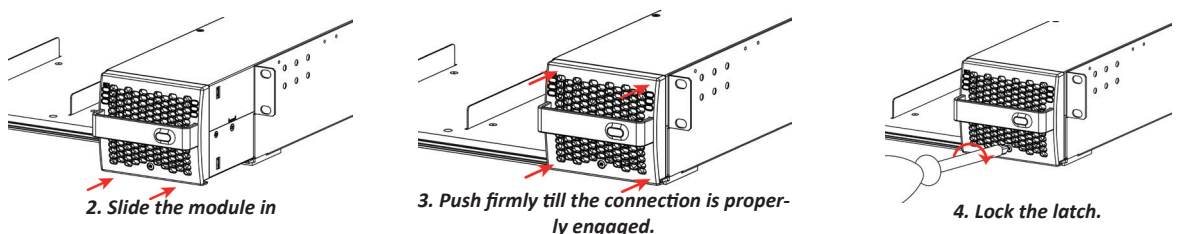

11.2 Inview S - Panel Mounting

Before mounting the Inview S in the system, route all the required connection cables from the system and place near to the Inview S mounting location.

1. Place the Inview S in the panel sheet.
2. Lock all the four latches at the rear side of the Inview S in the panel sheet.
3. Connect required connection cables to the Inview S.
4. Place the panel sheet in the system and fix it with screws.

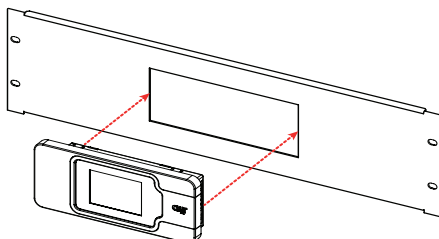

Place the Inview S in the panel sheet

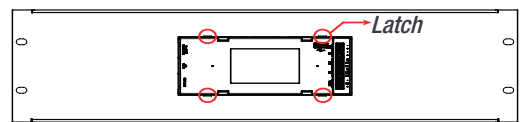

Fix it with four latches

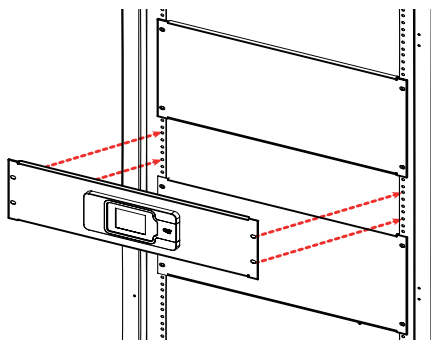

Connect wires and place the panel sheet in the cabinet

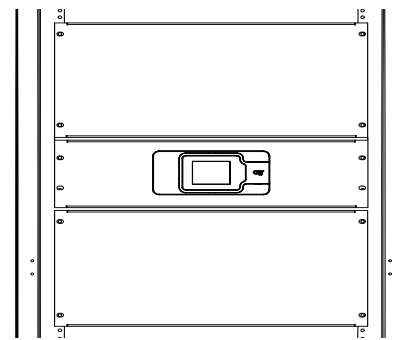

Fix the panel sheet with screws

Note: To know about panel sheet dimension and cut-out details, refer to the Inview user manual.

11.3 Inview X - Panel Mounting

Before mounting the Inview X in the system, route all the required connection cables from the system and place near to the Inview X mounting location.

1. Place the Inview X in the panel sheet.
2. Fix the Inview X in the panel sheet using four screws at the rear side.
3. Connect required connection cables to the Inview X.
4. Place the panel sheet in the system and fix it with screws.

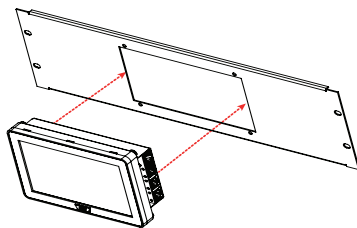

Place the Inview X in the panel sheet

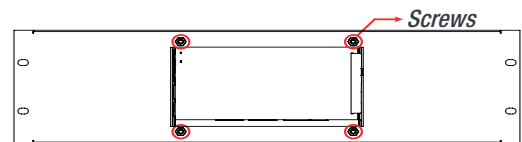

Fix it with four screws

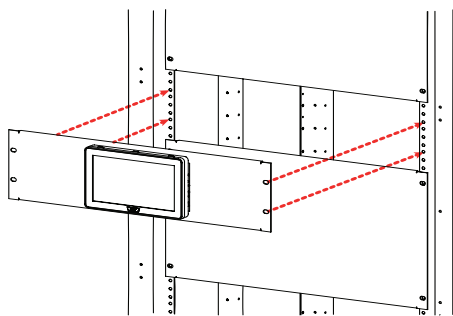

Connect wires and place the panel sheet in the cabinet

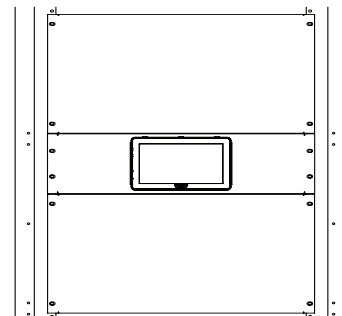

Fix the panel sheet with screws

Note: To know about panel sheet dimension and cut-out details, refer to the Inview user manual.

11.4 Fan replacement

The FAN life is approximately 60,000 (Sixty Thousand) hours. The inverter modules have fan runtime meters and fan failure alarms. Fan failure can result from a failing fan or driver circuit.

1. Let the module rest at least 5 minutes before initiating work. 
2. The inverter front cover must be removed. Use a screw driver and remove the screws on both side of the module.
3. Free up the fan. (Note the fan connector and wires position)
4. Disconnect the supply cord, and remove the fan.
5. Replace with new fan and connect supply cord.
6. Place the front cover and tighten the screws on both sides of the module.
7. Check fan for operation.
8. Access Inview and reset the fan run time alarm from within the action menu.

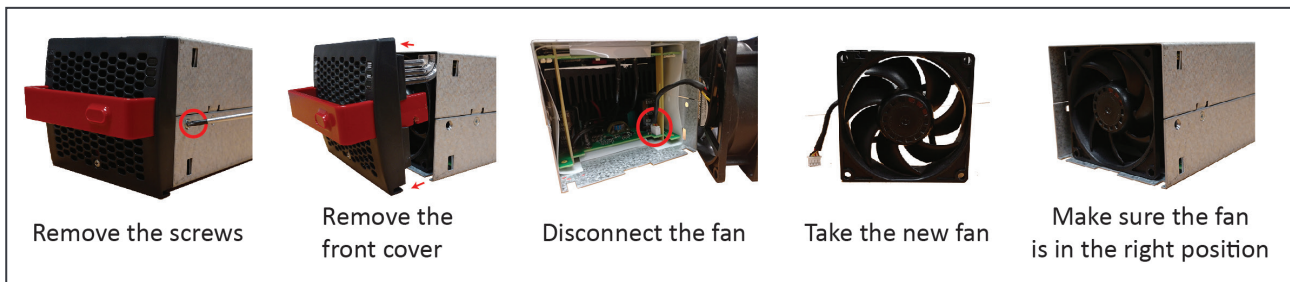

12. AC Output Distribution

12.1 Miniature Circuit breaker Installation/Removal

Circuit breakers are normally factory installed.

How to add breakers:

1. Insert the short connection cable (10 mm² (included)) in the breaker Line-side and tighten.
 - Up to 40 A breaker - use one connection cable.
 - 63 A breaker - use two connection cables.
2. Clip breaker on to the DIN rail.
3. Insert insulated screw driver into the terminal to load the spring.
4. Insert connection cable and remove screw driver.
5. Connect load cable to breaker, Neutral and Ground.
6. Switch breaker ON.

Remove breaker in reverse order

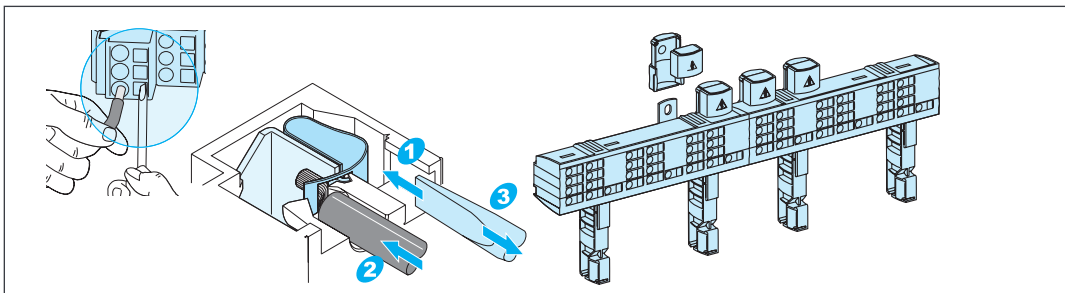

12.2 MCCB

MCCBs are factory installed.

A wide range of breakers is used. Delivered breakers may vary from the example shown in the picture.

1. Make sure that the breaker is in OFF position.
2. Connect load cables to the terminal.
3. Switch the breaker ON.



13. Manual By-Pass (MBP)

Manual By-Pass has to be operated by trained people only.

When system is in manual by-pass the load is subjected to mains voltage without active filtering. Output alarm is activated when system is in manual by-pass.

The Manual By-Pass cannot be operated remotely.

The Manual By-Pass can be integrated into the CE+T cabinet if requested at time of order. A Manual By-Pass purchased separately must comply with the instructions within section 13.2, page 54.

13.1 Pre-requisites

Commercial AC power must be present, and the inverter must be synchronized with it, before operating MBP. The upstream commercial breaker must be correctly sized to accept the overload, and if the AC is supplied by a Gen-set, the minimal required power will be twice the nominal power of the inverter.

The inverter may be overloaded during the MBP procedure, depending on voltage network and output. Inverter voltage setting: To reduce the impact of an overload, the inverter power and current will be reduced from 150% to nominal value.

The by-pass switch disconnects all AC voltage on the shelves but has no effect on the DC feeding the inverter and the remote alarm terminal.

It is requested in order to reduce the inrush current during manual by pass operation to adjust the inverter AC output voltage to the same value as AC input voltage. If the difference between AC input and AC output voltage exceed 5 Vac, there is a risk of shutdown of inverter due to high inrush current during the return to normal operation from Manual By Pass engaged.

13.2 MBP Auxiliary Connection

If manual by pass is installed in the system, then its auxiliary should be wired as per the following:

- MBP - Single rotary switch

Note: The below connection is for a sub-rack system, and auxiliary (Aux) number varies depending upon the MBP switch. So it is recommended to refer the technical sheet received along with the system.

- Connect Aux3 of MBP to Digital Input 01 of controller. So that the controller gets information when MBP is engaged.
- Connect Aux1 and Aux2 of MBP to Remote ON/OFF terminal in the shelf where controller is installed.

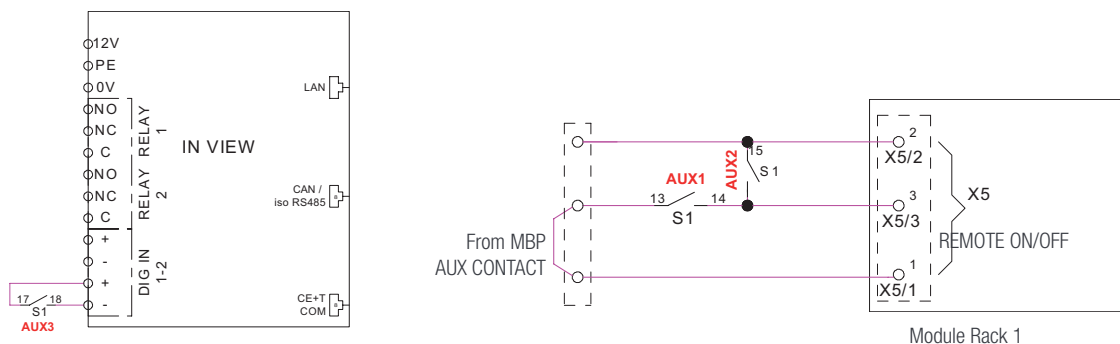

- **MBP - Three independent switch**

- Connect auxiliary wire from MBP switch (S1) to Digital Input 01 of controller. So that the controller gets information when MBP is engaged.
- Connect auxiliary wire from MBP switch (S1) and AC input switch (S3) to Remote ON/OFF terminal in the shelf where controller is installed.

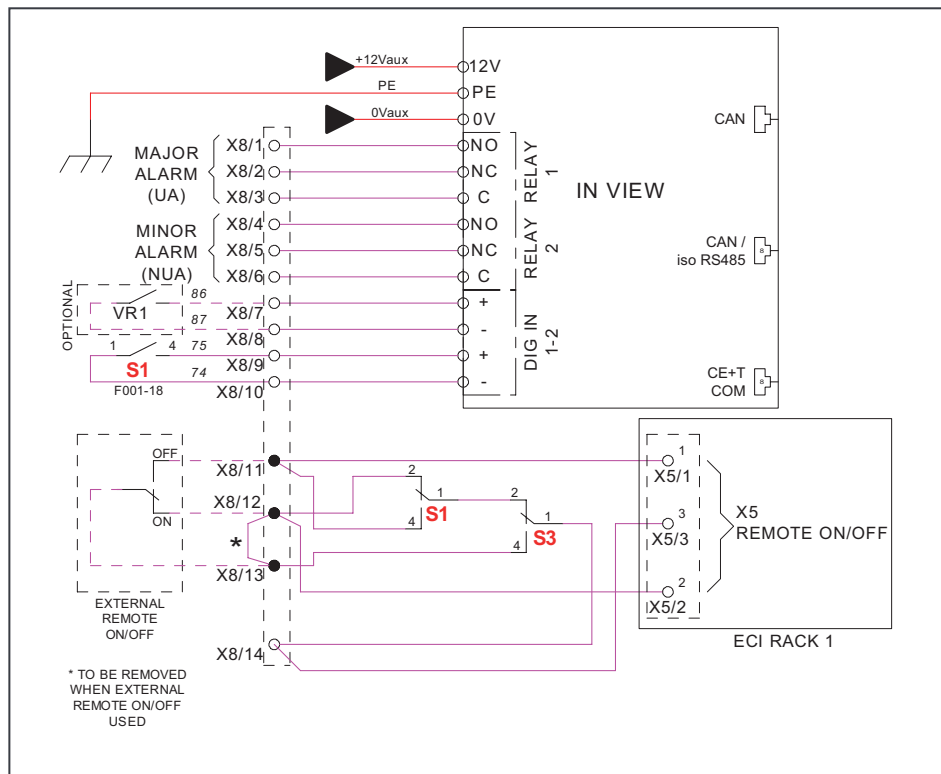

13.3 Manual Bypass operation

Manual Bypass operation creates a bypass from mains input via output AC distribution. Inverter modules are bypassed and possible to disconnect without impacting the load.

Manual By-Pass operation is “Make before Break” logic.

The Bravo 25 system has a single rotary switch or three individual switches depending upon the system configuration, and the operation also varies for each model.

13.3.1 MBP - Single rotary switch

In this model, manual bypass operates in single switch and it has three positions - Normal, Interim and Bypass.

13.3.1.1 Normal to Bypass

1. Rotate the MBP Switch (S1) from **NORMAL** to **BYPASS**. (Note: Do not stop at **INTERIM** position)
2. Switch **OFF** the DC power and/or disconnect batteries.

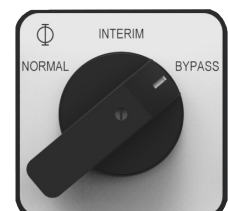

13.3.1.2 By-Pass to Normal

1. Switch **ON** the DC power and/or connect batteries.
2. Rotate the MBP Switch (S1) from **BYPASS** to **INTERIM**.
(Wait until the modules turn on and synchronized, approximately 30-60 seconds).
3. Rotate the MBP Switch (S1) from **INTERIM** to **NORMAL**.

13.3.2 MBP - Three individual switches

In this model, manual bypass operates through three individual switches - S1 (Manual Bypass), S2 (AC out) and S3 (AC IN).

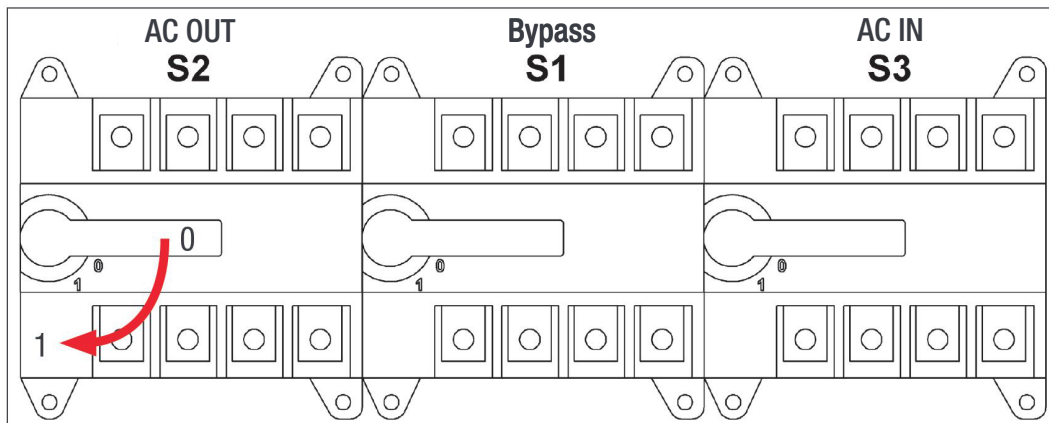

13.3.2.1 Normal to By-Pass

1. Close the By-Pass switch **S1**, 0 to 1
2. Open the AC Out switch **S2**, 1 to 0
3. Open the AC IN switch **S3**, 1 to 0
4. Switch **OFF** the DC power and/or disconnect batteries

13.3.2.2 By-Pass to Normal

1. Switch **ON** the DC power and/or connect batteries.
2. Close the AC IN switch **S3**, 0 to 1
(Wait until the modules turn on and synchronized, approximately 30-60 seconds).
3. Close the AC Out switch **S2**, 0 to 1
4. Open the By-Pass switch **S1**, 1 to 0

14. Finishing

- Make sure that the sub-rack/cabinet is properly fixed to the cabinet/floor.
- Make sure that the sub-rack/cabinet is connected to Ground.
- Make sure that all DC and AC input breakers are switched OFF.
- Make sure that all cables are according to recommendations and local regulations.
- Make sure that all cables are strained relieved.
- Make sure that all breakers are according to recommendation and local regulations.
- Make sure that DC polarity is according to marking.
- Re tighten all electrical terminations.
- Make sure that no inverter/controller positions are left open.
- Cover empty inverter positions with dummy modules.
- Make sure that the Remote ON/OFF is appropriately wired according to local regulations.
- Make sure that the point of AC supply meets local regulations.

15. Commissioning

The DC breaker is a protection device. Modules are plugged in a system and DC breaker is then engaged. Please make sure the corresponding DC breaker is engaged in the ON position. Failure to observe this rules will result not to have all module operating when running on DC and have module failure when AC input recover from fault condition.

Installation and commissioning must be done and conducted by trained people fully authorized to act on installation.

It is prohibited to perform any isolation test without instruction from manufacturer.

Equipments are not covered by warranty if procedures are not respected.

15.1 Check list

DATA	
Date	
Performed by	
Site	
System serial number	
Module serial numbers	
Inview Serial number	
ACTION	OK/ N.OK
Unplug all Inverters except one Inverter per phase. (Just pull off the Inverter from the shelf, to interrupt electrical contacts)	
Check the commercial AC before closing the AC input breaker.	
Switch ON the commercial AC.	
Check if Inverters are working (Green led).	
Check the DC power supply and switch ON the DC breakers.	
Plug in all Inverters one by one.	
Check output voltage. (on bulk output or on breaker)	
Check if Inverters are working properly.	
Check if system has no alarm. (Disable the alarm if any)	
Read configuration file and review all parameters. Some parameters must be adapted according to the site. (LVD, load on AC, AC threshold level)	
Switch OFF ACin and check if system is working on DC.	
Switch ON ACin and check if system correctly transferred load on AC.	
Switch OFF system and start on AC only.	
Switch OFF system and start on DC only.	
Check if display working properly (Inview).	
Check if TCPIP working properly. (if this option is present)	
Test on load. (if available)	
ALARM	
Switch ON AC input and DC input and check that no alarm are present.	
Pull out one Inverter and check alarm according to redundancy.	
Pull out two Inverters and check alarm according to redundancy.	
Switch OFF AC input (commercial power failure) and check the alarm according to the configuration.	
Switch OFF DC input (DC power failure) and check that the alarm according to the configuration.	
Check the different digital input according to the configuration. (when used)	

16. Trouble Shooting and Defective Situations Fixing

16.1 Trouble Shooting

Inverter module does not power up: Check AC input present and in range (AC breakers)

Check DC input present and in range (DC breakers)

Check that the Inverter is properly inserted

Remove Inverter to verify that slot is not damaged, check connectors

Check that module(s) is (are) in OFF state

Check for loose terminations

Inverter system does not start:

Check that Inview is present and properly connected

Check remote ON/OFF terminal

Check the configuration and setting

Check threshold level

Inverter only run on AC or DC:

Check AC input present and in range (AC breakers)

Check DC input present and in range (DC breakers)

Check the configuration and setting

Check threshold level(s)

No output power:

Check output breaker

All OK but I have alarm:

Check the type of event and log file in the controller

No alarm:

Check relay delay time of alarms in the controller

Check configuration file

16.2 Defective modules

- A repair request should follow the regular logistics chain:
End-user => Distributor => CE+T Power.
- Before returning a defective product, a RMA number must be requested through the <http://my.cet-power.com> extranet. Repair registering guidelines may be requested by email at repair@cet-power.com.
- The RMA number should be mentioned on all shipping documents related to the repair.
- Be aware that products shipped back to CE+T Power without being registered first will not be treated with high priority! (Label shown here is only for representation)

17. Maintenance

Maintenance should be performed by properly trained people.

17.1 Access Inview with Laptop

- Download system LOG FILE and save
 - Analyse log file and correct errors
- Download system CONFIGURATION FILE and save
 - Check/correct configuration file according to operation conditions
 - Check/correct alarm configuration
- Check module internal temperature for deviation between modules
 - Temperature deviation may indicate build up of dust. Clean the module by air suction blower or vacuum cleaner.
- Check module/system load
- Check/Correct inverter mapping (DC Group/AC Group/ Address)

17.2 Manual check

- Check voltages of AC Input, DC Input, AC Output and DC Output using the multi-meter.
- Replace door filter if more dust is accumulated.
- Take a snap shot of the cabinet and site condition.

17.3 Optional

- With an infrared camera check termination hot spots:
 - Tighten terminations

17.4 Manual By-Pass

- Make sure AC input source is available during MBP operation. Otherwise the LOAD will be affected.

18. Service

For Service

- Check Service Level Agreement (SLA) of your vendor. Most of the time they provide assistance on call with integrated service. If such SLA is in place, you must call their assistance first.
- If your vendor doesn't provide such assistance (*) you may contact CE+T through email: customer.support@cet-power.com

(*) CE+T will redirect your call to your vendor if he has such SLA in place.

19. Appendix

19.1 Mains connection, Single phase

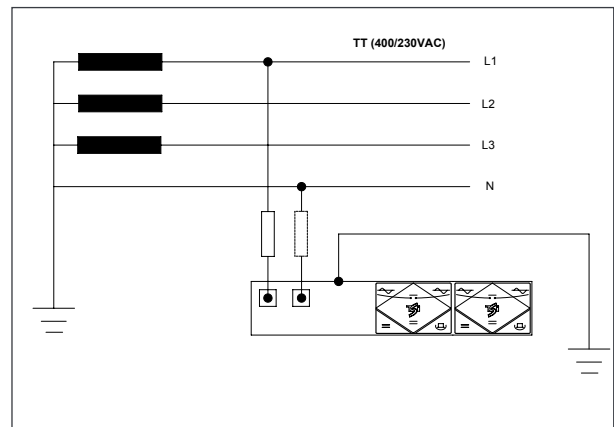
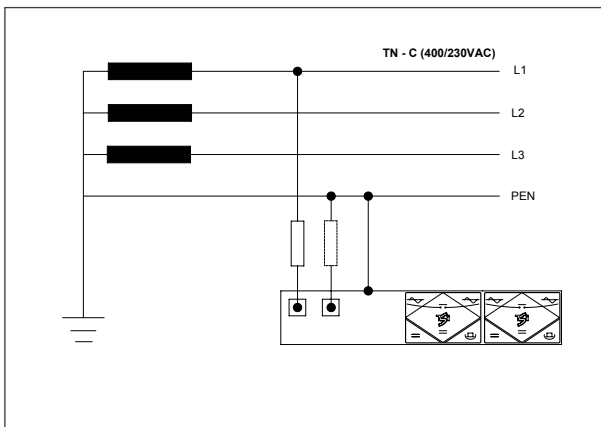
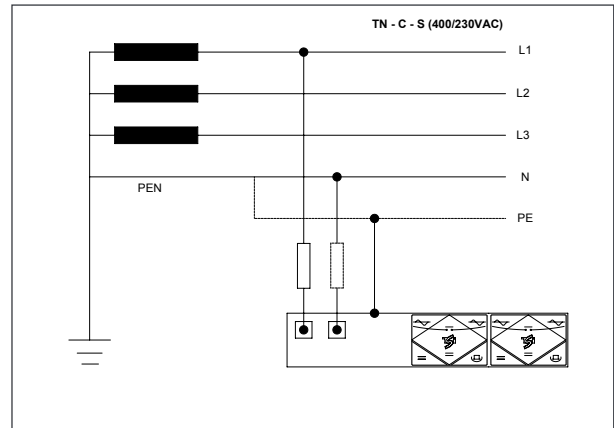
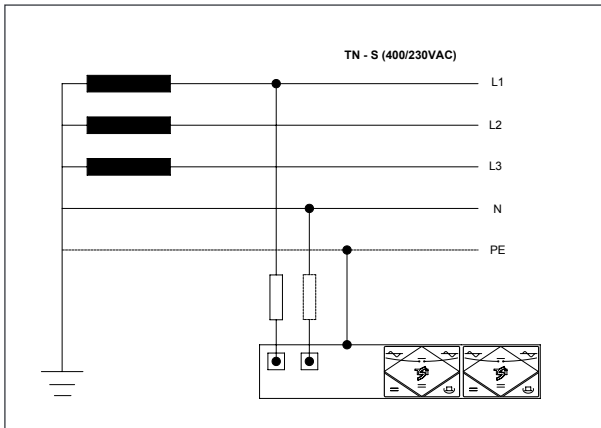

19.2 Mains connection, Three phases

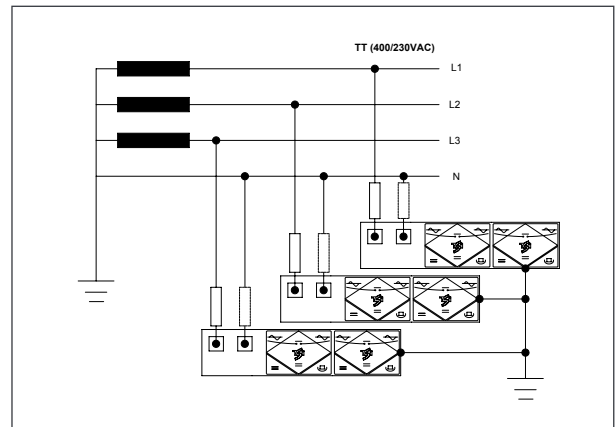
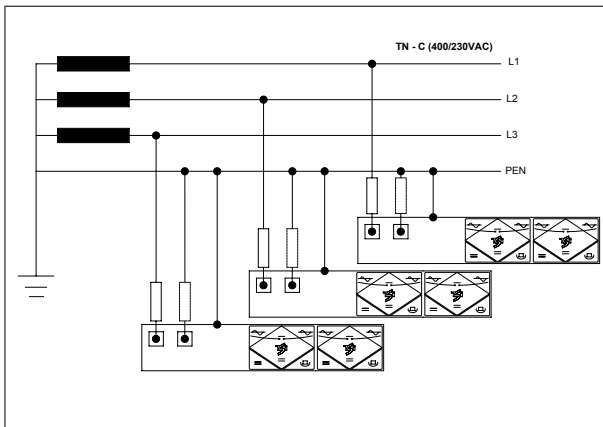
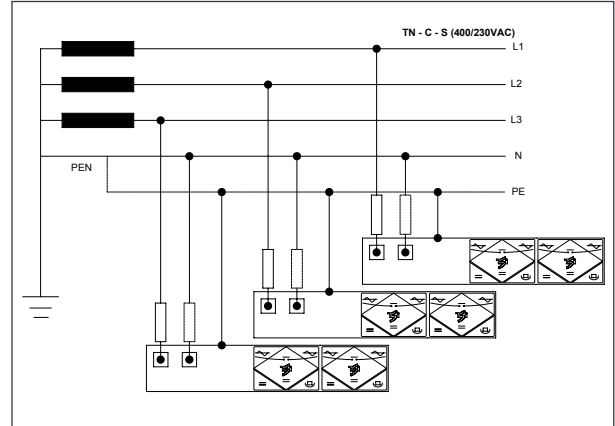
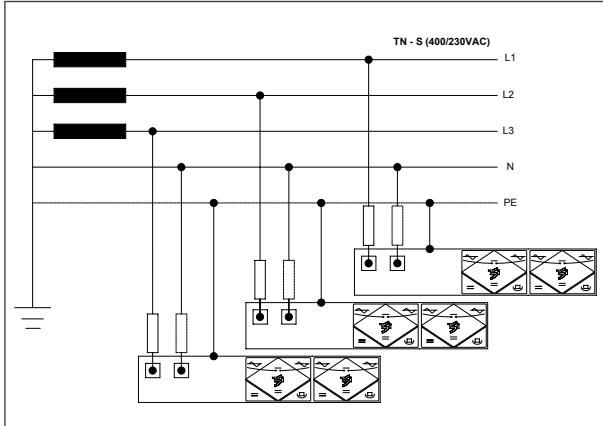

19.3 Bravo 25 - Dimensions

19.3.1 Module

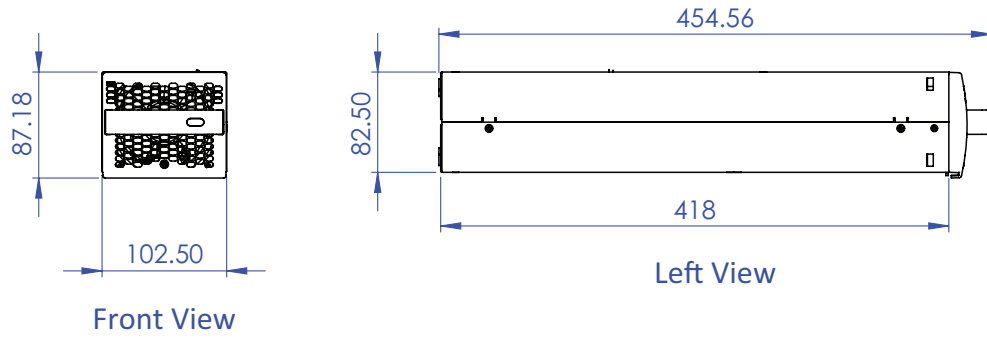

19.3.2 Shelf

